

GARMIN®



Varia™ eRTL615

Owner's Manual

© 2023 Garmin Ltd. or its subsidiaries

All rights reserved. Under the copyright laws, this manual may not be copied, in whole or in part, without the written consent of Garmin. Garmin reserves the right to change or improve its products and to make changes in the content of this manual without obligation to notify any person or organization of such changes or improvements. Go to www.garmin.com for current updates and supplemental information concerning the use of this product.

Garmin®, the Garmin logo, ANT+®, Edge®, fenix®, Forerunner®, Venu®, and vivoactive® are trademarks of Garmin Ltd. or its subsidiaries, registered in the USA and other countries. Garmin Connect™, Garmin Express™, and Varia™ are trademarks of Garmin Ltd. or its subsidiaries. These trademarks may not be used without the express permission of Garmin. The BLUETOOTH® word mark and logos are owned by the Bluetooth SIG, Inc. and any use of such marks by Garmin is under license.

M/N: A04540

Country restrictions apply. 010-02790-00 is approved for operation in France and the United Kingdom. 010-02789-00 is approved for operation in Germany. 010-02791-00 is approved for operation in European countries outside of Germany, France, and the United Kingdom.

Table of Contents

Introduction.....	1	Pairing the Varia eRTL615 with a Compatible Edge Bike Computer.....	12
Getting Started.....	1	Pairing the Radar Device with a Compatible Garmin Watch.....	13
Tips for Installing the Device.....	1	Device Information.....	13
Installing the Device on a Seat Mount.....	2	Device Care.....	13
Installing the Device on a Rear Rack.....	3	Radar Detection.....	13
Device Overview.....	4	Specifications.....	14
Varia eRTL615 Status LED.....	5	Troubleshooting.....	14
Tail Light Modes and Intensity.....	5	Resetting the Device.....	14
Turning Off the Varia eRTL615 Tail Light.....	5	Product Updates.....	14
The Varia eRTL615 and Your Edge 1040.....	5	The radar device is not responding.....	15
Pairing the Varia eRTL615 with Your Edge 1040.....	6	My phone will not connect to the device.....	15
Viewing Radar on Your Edge Bike Computer.....	6	Radar detection does not work indoors.....	15
Tone Alerts for Approaching Vehicles.....	6	The status LED is flashing yellow.....	15
Viewing Widgets.....	7	The status LED turns red while updating the software.....	15
Customizing the Varia Device Settings with Your Edge 1040.....	7	The status LED turns red while plugged into a power source.....	16
Customizing the Radar Alert Settings with Your Edge 1040.....	8	The radar device disconnects from the Edge bike computer.....	16
The Varia eRTL615 and the Varia App.....	8	The radar device disconnects from the Varia app.....	16
Pairing the Varia eRTL615 with Your Phone.....	8	The radar device disconnects from the Varia RDU device.....	16
Viewing Radar on the Varia App.....	9	Getting More Information.....	16
Customizing the Varia App Alert Settings.....	9		
The Varia eRTL615 and Your Radar Display Unit.....	9		
Varia RDU Overview.....	10		
Installing the Varia RDU.....	11		
Pairing the Radar Device with the Varia RDU.....	11		
Turning On the Varia RDU.....	12		
Turning Off the Varia RDU and Radar Device.....	12		
Other Compatible Devices.....	12		

Introduction

WARNING

See the *Important Safety and Product Information* guide in the product box for product warnings and other important information.

The device can improve situational awareness. It is not a replacement for cyclist attentiveness and good judgement. Always maintain awareness of your surroundings, and operate the bicycle in a safe manner. Failure to do so could result in serious injury or death.

Always consult your physician before you begin or modify any exercise program.

Getting Started

You can use the Varia eRTL615 with your compatible Garmin® device or a phone. This list provides an overview of the installation and setup tasks.

- Install the tail light mount ([Installing the Device on a Rear Rack, page 3](#)).
- If you are using an Edge® series bike computer, pair the devices ([The Varia eRTL615 and Your Edge 1040, page 5](#)).
- If you are using your phone, download the Garmin Varia app to your phone, and pair the devices ([Pairing the Varia eRTL615 with Your Phone, page 8](#)).
- If you are using another Garmin device, pair the devices ([Other Compatible Devices, page 12](#)).

Tips for Installing the Device

The Varia eRTL615 includes a tail light and micro radar that can detect approaching vehicles up to 140 meters away.

- Select a secure location to mount the device where it does not interfere with the safe operation of your bike.
- Mount the device as high as possible for optimal light visibility and radar detection.
NOTE: The mount surface should be vertical. The devices are designed to accommodate most bike rack angles.
- Mount the device 250 mm to 1200 mm above the road.
- Ensure the device faces backward and is perpendicular to the road.

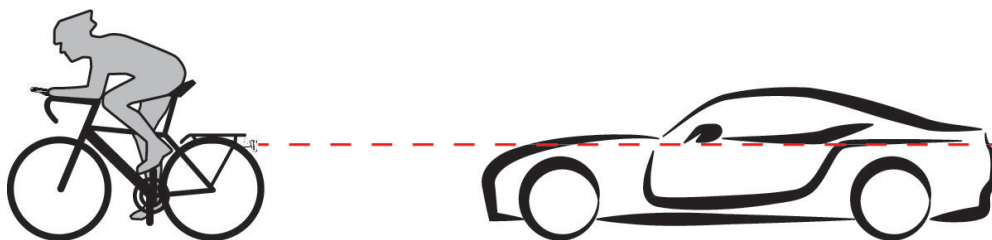

- Make sure there are no obstructions in front of the light.
- Go for a test ride during the day in a safe environment.

Installing the Device on a Seat Mount

Before you can install the Varia eRTL615 tail light, you need 3 mm and 4 mm hex keys and a cable to connect your device.

- 1 Attach the friction flange adapter ① to your Varia eRTL615 tail light using two M4 screws.
- 2 Using a 3 mm hex key, tighten the two M4 screws to 1 N-m (9 lbf-in.).
- 3 If you have other attachments on the back of your seat, attach the extender ② to the friction flange adapter using an M5 screw.

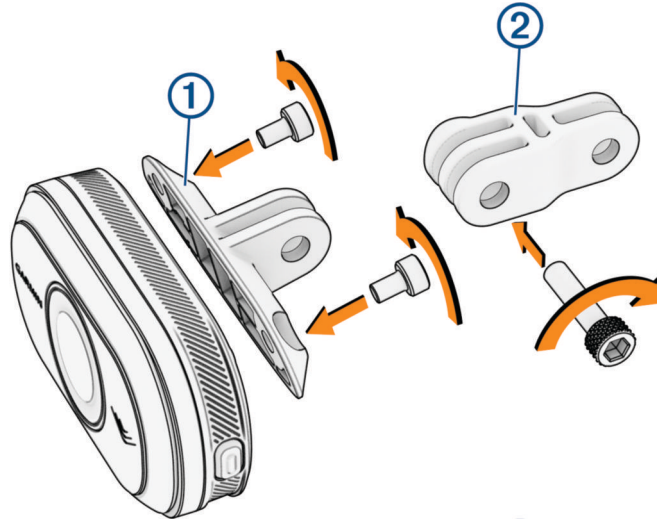

- 4 Align the hole in the friction flange adapter or the extender with the hole in the center of the seat mount bracket.
- 5 Attach the device to the seat mount bracket loosely using an M5 screw.
NOTE: The M5 screw will be fully tightened after positioning the device on your bike.
- 6 Attach the bracket ③ to the rails under the seat.

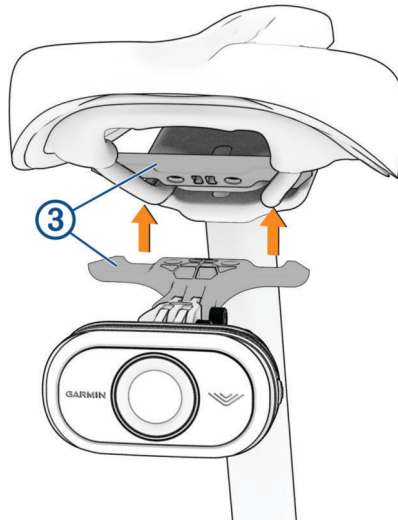

- 7 Using a 4 mm hex key, tighten the two M5 screws on the bracket to 2 N-m (18 lbf-in.).
- 8 Position the device ([Tips for Installing the Device, page 1](#)).

- 9 Using a 4 mm key, tighten the M5 screws on the friction flange adapter and extender to 3 N-m (27 lbf-in.).



- 10 Connect the cable to your bike.

If necessary, consult the owner's manual for your bike for additional information on connecting devices.

- 11 Secure the cable so that it does not interfere with any moving parts of the bike.

Installing the Device on a Rear Rack

Before you can install the Varia eRTL615 tail light, you need 3 mm and 4 mm hex keys and a cable to connect your device.

- 1 Complete the required steps based on the configuration of your rear rack:
- If the rear rack can accommodate the friction flange adapter, complete steps 2 through 5.
 - If the device can be attached directly to the rear rack, complete steps 6 through 9.

- 2 Attach the friction flange adapter ① to your Varia eRTL615 tail light using two M4 screws.

TIP: For longer bike racks or if you have other attachments on the back of your bike, attach the extender ② to the friction flange adapter.

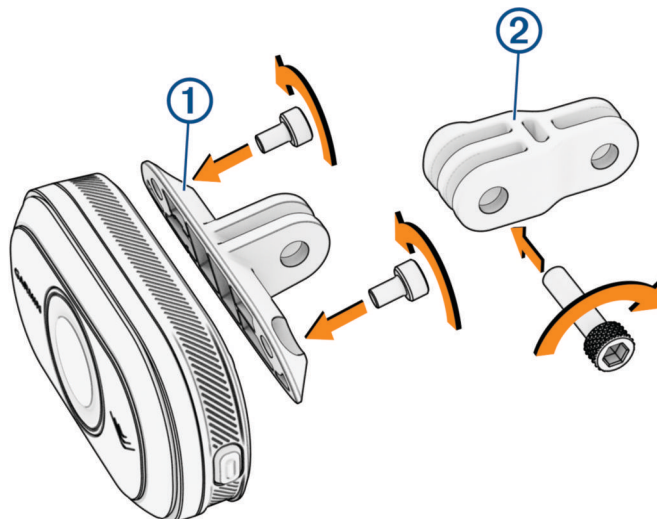

- 3 Using a 3 mm hex key, tighten the two M4 screws to 1 N-m (9 lbf-in.).

- 4 Align the hole in the friction flange adapter or extender with the hole in the rear rack of your bike.

- Using a 4 mm hex key, tighten the M5 screw to 3 N-m (27 lbf-in.).

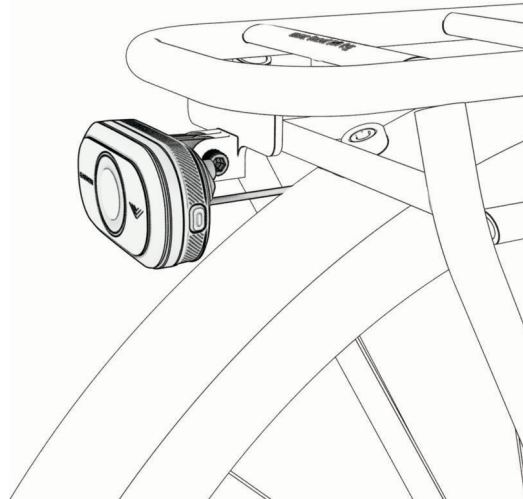

- If you are not using a friction flange adapter, align the holes in the rear rack of your bike with the holes on the back of your Varia eRTL615 tail light.
- Using a 3 mm hex key, tighten the two M4 screws to 1 N-m (9 lbf-in.).
- Connect the cable to your bike.
Consult the owner's manual for your bike for additional information on connecting devices.
- Secure the cable so that it does not interfere with any moving parts of the bike.

Device Overview

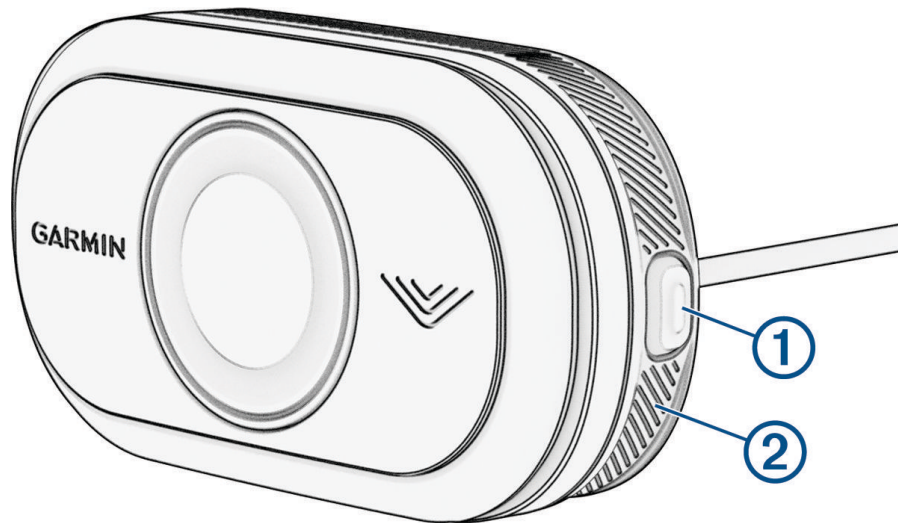

<p>① Device button</p>	<p>Press to change device and light modes. Hold for 1 second to turn the device on and enter active mode. Hold for 4 seconds to enter pairing mode (Pairing the Varia eRTL615 with Your Phone, page 8). When the device is in sleep mode, hold for 2 seconds to wake the device. Hold for 2 seconds to turn the tail light off. Hold for 10 seconds to reset the device.</p>
<p>② Device status LED</p>	<p>Changes color based on the pairing status and device mode status (Varia eRTL615 Status LED, page 5).</p>

Varia eRTL615 Status LED

LED State	Status
Flashing purple	The device is in active pairing mode.
Flashing blue	The device is in smart mode and can be controlled by a paired compatible Garmin device.
Single blue flash	The device entered smart sleep mode.
Double blue flash	The device entered active mode.
Flashing yellow	The device is in demo mode.
Flashing blue and green alternating	The device is applying a firmware update.
Flashing green 10 times	The device successfully applied a firmware update.
Flashing red 10 times	The device was unable to apply a firmware update.
Solid red	An error occurred. You may need to restart the device.

Tail Light Modes and Intensity

You can switch the Varia eRTL615 tail light modes by pressing the button ([Device Overview, page 4](#)).

Mode	Light Intensity	Default Flash Behavior	Function
Solid (default)	High	None	The tail light is on, and the device detects vehicles.
Peloton (group ride)	Moderate	None	The tail light flashes softly when the device detects vehicles.
Night Flash	High	Slow	The tail light flashes quickly when the device detects vehicles.
Day Flash	Maximum	Occasional	The tail light flashes quickly when the device detects vehicles.
Standby	Off	None	The tail light is off, and the device continues to detect vehicles.

Turning Off the Varia eRTL615 Tail Light

Hold the device button for 2 seconds ([Device Overview, page 4](#)).

The radar continues to function while the tail light is off.

The Varia eRTL615 and Your Edge 1040

You can remotely control your radar device and customize settings using your compatible Edge bike computer. This section contains instructions for the Edge 1040. Other compatible Edge bike computers contain similar settings and controls ([Other Compatible Devices, page 12](#)).

Pairing the Varia eRTL615 with Your Edge 1040

The first time you connect the Varia eRTL615 to your Edge 1040, you must pair both devices using ANT+® technology. After the initial pairing, the Edge device automatically connects to the radar device when you start your activity and the radar device is active and within range.

NOTE: The radar device is compatible with other Garmin devices ([Other Compatible Devices, page 12](#)).

1 Bring the Edge 1040 within range (3 m) of the sensor.

NOTE: Stay 10 m away from other wireless sensors while pairing.



2 Turn on the Edge 1040.

3 Select  > **Sensors** > **Add Sensor** > **Search All**.

4 While the Varia eRTL615 is turned off, hold the device button for 4 seconds to enter pairing mode.

The status LED flashes purple, and the tail light turns on. The device is in pairing mode for 5 minutes or until you hold the device button for 2 seconds to exit pairing mode.

5 Select your sensor, and select **Add**.

When the sensor is paired with your Edge 1040, the sensor status is Connected. The  (radar) and  (bike light) status icons appear solid on the top banner of the home screen.

Viewing Radar on Your Edge Bike Computer

Go for a ride.

The radar information appears on the active data screen.

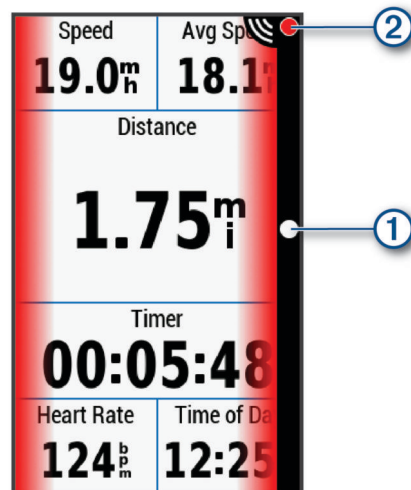

The vehicle position LED (1) moves up the column as a vehicle gets closer to your bike. The threat level LED (2) changes color based on the potential level of threat. Green indicates no vehicle is detected. Amber indicates a vehicle is approaching. Red indicates a vehicle is advancing at a high rate of speed.

Tone Alerts for Approaching Vehicles

The Edge device beeps if audible tones are turned on in the settings. Your device has alert tones for several features. The alert tone for approaching vehicles has a unique sound. The device beeps one time when the first vehicle is detected. After the threat is cleared, the device beeps again when another vehicle is detected.

Viewing Widgets

Your device is preloaded with several widgets, and more are available when you pair your device with a phone or other compatible device.

- 1 From the home screen, swipe down from the top of the screen.

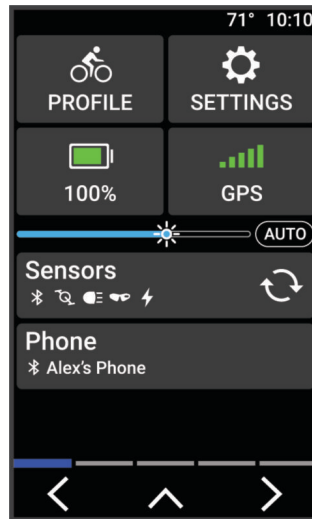

The settings widget appears. A flashing icon means the device is searching for a signal. A solid icon means the signal was found or the sensor is connected. You can select any icon to change the settings.

- 2 Swipe left or right to view more widgets.

The next time you swipe down to view the widgets, the last widget you viewed appears.

Customizing the Varia Device Settings with Your Edge 1040

Before you can customize Varia eRTL615 settings with your Edge 1040, you must pair the devices.

- 1 Select  > **Sensors** > **Lights**.
- 2 Select an option:
 - Select **Enable** to enable the light network.
 - Select **Network Options** > **Test Lights** to verify that each light in your network is set up correctly ([Testing the Light Network, page 7](#)).
 - Select a light to view device information and customize each light in your network ([Light Network Settings, page 7](#)).

Testing the Light Network

- 1 From the **Sensors** menu, select **Lights** > **Network Options** > **Test Lights**.
- 2 Select a light to test.

The light blinks when it is connected.

Light Network Settings

From the **Sensors** menu, select **Lights**, and select a paired light.

Enable: Turns on the light and allows you to control the light remotely with your Edge bike computer. You can disable a light to disconnect it from the light network.

Light Mode: Sets the light intensity and pattern mode, or turns off the light.

NOTE: This setting is available when you select the Individual light mode setting ([Light Mode Settings, page 8](#)).

About: Displays device, software, and battery information.

Remove: Allows you to delete a paired light from the network.

Light Mode Settings

From the **Sensors** menu, select **Lights > Network Options > Light Mode**.

Auto: Automatically adjusts the light intensity and light mode based on the ambient light and time of day.

High Visibility: Sets the light intensity to flash mode or the brightest setting available.

Trail: Automatically adjusts the light intensity and light mode based on the ambient light and time of day. This mode is recommended for mountain biking.

Individual: Allows you to customize the light intensity and pattern mode for each light in your network ([Light Network Settings, page 7](#)).

Customizing the Radar Alert Settings with Your Edge 1040

Before you can customize the radar alert settings with your Edge 1040, you must pair the devices.

You can customize how the radar alerts sound and display on your Edge 1040.

- 1 From your Edge 1040, select  > **Sensors**.
- 2 Select your Varia eRTL615.
- 3 Select **Sensor Details > Alert Settings**.
- 4 Select an option.

The Varia eRTL615 and the Varia App

The Varia app connects to your Varia eRTL615 using Bluetooth® technology. The app displays radar information and settings.

- After pairing, the app displays a colored banner indicating the threat level posed by approaching vehicles.
- You can enable phone vibration alerts so you can monitor those alerts while your phone is in your pocket, instead of mounted on the handlebar.

You can download the Varia app from the app store on your phone.

Pairing the Varia eRTL615 with Your Phone

The first time you connect the Varia eRTL615 to the Varia app on your phone, you must pair both devices. After the initial pairing, the Varia app automatically connects to the Varia eRTL615 when you open the app and the radar device is active and within range.

- 1 Bring your phone within range (0.5 m) of the Varia eRTL615.
NOTE: Stay 10 m away from other Bluetooth sensors while pairing.
- 2 On your compatible phone, enable Bluetooth technology.
- 3 From the app store on your phone, install and open the Varia app.
- 4 Select **Pair Now**.
- 5 While the Varia eRTL615 is turned off, hold the device button for 4 seconds to enter pairing mode.
The device status LED flashes purple, and the tail light turns on. The device is in pairing mode for 5 minutes or until you hold the device button for 2 seconds to exit pairing mode.
- 6 Select **That's Mine**.

When the Varia eRTL615 is paired with your phone, the app displays the current radar status.

Viewing Radar on the Varia App

Go for a ride.

The radar information appears on the active data screen.

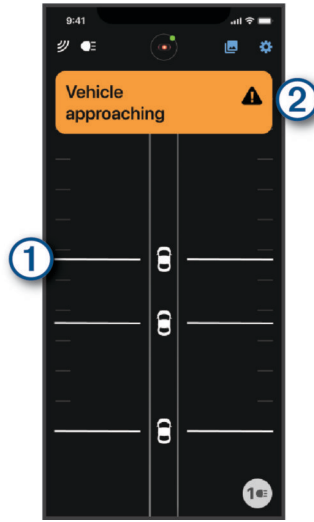



The vehicle position ① moves up the screen as a vehicle gets closer to your bike. The threat level banner ② changes color based on the potential level of threat. Green indicates no vehicle is detected. Amber indicates a vehicle is approaching. Red indicates a vehicle is advancing at a high rate of speed.

TIP: The line next to the vehicle also indicates the threat level. A straight line changes to jagged with a red threat level.

Customizing the Varia App Alert Settings

Before you can customize the radar alert settings with the Varia app, you must pair the devices.

You can enable vibration alerts on your phone so you can monitor those alerts while your phone is in your pocket, instead of mounted on the handlebar.

- 1 From the Varia app, select  or .
- 2 Select **Sounds & Alerts**.
- 3 Select an option.

The Varia eRTL615 and Your Radar Display Unit

You can display radar data using the compatible rear display unit (RDU).

Varia RDU Overview

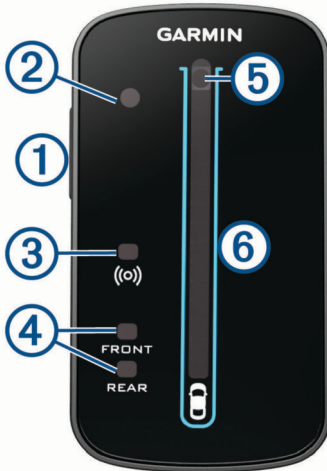

<p>① Device button</p>	<p>Turns the device on and off.</p>
<p>② Ambient light sensor</p>	<p>Detects available light and automatically adjusts the brightness of the display.</p>
<p>③ Connection status LED</p>	<p>Appears solid blue when the device is paired with the radar device. Flashes blue when the device is searching for the radar device.</p>
<p>④ FRONT and REAR device status LEDs</p>	<p>Appears solid red when there is a device error.</p>
<p>⑤ Threat level LED</p>	<p>Changes color based on the potential level of threat. Green indicates no vehicle is detected. Amber indicates a vehicle is approaching. Red indicates a vehicle is advancing at a high rate of speed.</p>
<p>⑥ Vehicle position LEDs</p>	<p>Moves up the column as the vehicle gets closer to your bike.</p>

Installing the Varia RDU

NOTE: If you do not have a Varia RDU, you can use a compatible Edge bike computer or the Varia app on your phone (*The Varia eRTL615 and the Varia App, page 8*).

You can install the device on the stem or the handlebars.

- 1 Select a secure location to mount the device where it does not interfere with the safe operation of your bike.
- 2 Place the rubber disk ① on the back of the bike mount.
The rubber tabs align with the back of the bike mount so it stays in place.

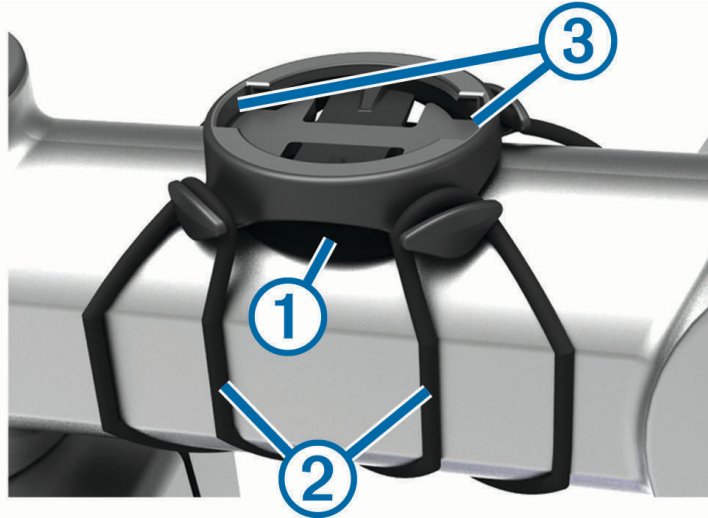

- 3 Place the bike mount on the bike stem.
- 4 Attach the bike mount securely using the two bands ②.
- 5 Align the tabs on the back of the device with the bike mount notches ③.
- 6 Press down slightly and turn the device clockwise until it locks into place.

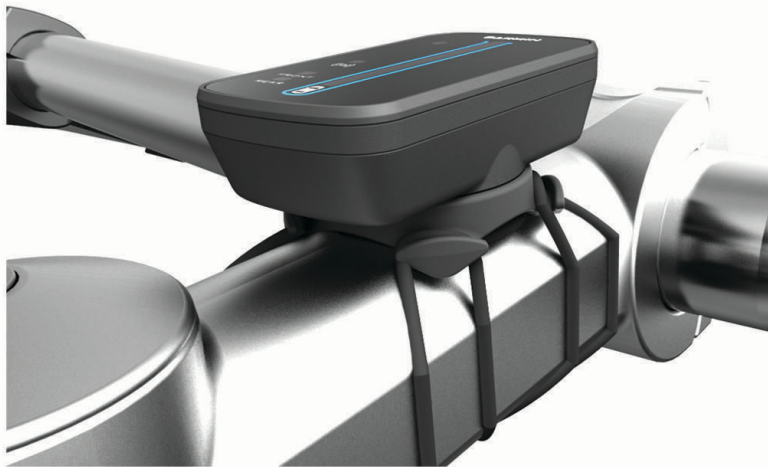

Pairing the Radar Device with the Varia RDU

The Varia RDU can be paired with one radar device at a time.

- 1 Hold the Varia RDU device button for 5 seconds.
The threat level LED flashes purple.
- 2 Turn on the radar device.
- 3 Bring the devices within 1 cm of each other, and wait while the devices connect.
The Varia RDU (📶) LED turns solid blue and the threat level LED turns solid green.

Turning On the Varia RDU

Hold the device button for 1 second to turn on the radar device.

The LEDs fill the column to indicate the battery level.

The  LED flashes blue while it is searching for the radar device.

Varia RDU Battery Status LED

When you turn on the device, the LED at the top of the column briefly indicates the battery status.

LED Activity	Status
Flashing green	The device is charging.
Solid green	Charging is complete.
Flashing yellow	The battery is low.
Flashing red	The battery is critically low.

Setting the Varia RDU Device Tones

- Press the device button to turn on tones.
- Press the device button again to turn off tones.

Turning Off the Varia RDU and Radar Device

If the Varia RDU device is paired with the radar device, you can turn off both devices at the same time.

Hold the device button on the Varia RDU for 1 second.

Other Compatible Devices

Pairing the Varia eRTL615 with a Compatible Edge Bike Computer

This task is for the Edge 1040, 830, and 530 bike computers. If your Edge series is not listed, go to buy.garmin.com.

- 1 Bring the Edge bike computer within range (3 m) of the Varia eRTL615.
NOTE: Stay 10 m away from other sensors that use ANT+ technology while pairing.
- 2 Turn on the Edge bike computer.
- 3 From the **Sensors** menu, select **Add Sensor > Search All**.
- 4 While the Varia eRTL615 is turned off, hold the device button for 4 seconds to enter pairing mode.
The status LED flashes purple, and the radar tail light turns on. The radar tail light is in pairing mode for 5 minutes or until you hold the device button for 2 seconds to exit pairing mode.
- 5 Select your sensor.

When the radar tail light is paired with your Edge bike computer, the radar and bike light status icons appear solid.

Pairing the Radar Device with a Compatible Garmin Watch

This task is for the Forerunner® 955, fēnix® 7 series, and Venu® 2 series watches. If your watch is not listed, go to buy.garmin.com.

NOTE: Not all Varia eRTL615 features are available on all compatible watches. See your watch owner's manual.

1 Bring the watch within range (3 m) of the sensor.

NOTE: Stay 10 m away from other ANT+ sensors while pairing.

2 Turn on the Garmin watch.

3 From the **Settings** menu, select **Sensors & Accessories > Add New > Search All**.

4 While the Varia eRTL615 device is turned off, hold the device button for 4 seconds to enter pairing mode.

The status LED flashes purple, and the tail light turns on. The device is in pairing mode for 5 minutes or until you hold the device button for 2 seconds to exit pairing mode.

5 Select your sensor.

When the sensor is paired with your Garmin watch, the radar and bike light status icons appear solid.

Device Information

Device Care

NOTICE

Do not store the device where prolonged exposure to extreme temperatures can occur, because it can cause permanent damage.

Avoid chemical cleaners, solvents, sunscreen, and insect repellents that can damage plastic components and finishes.

Secure the weather cap tightly to prevent damage to the USB port.

Avoid extreme shock and harsh treatment, because it can degrade the life of the product.

Cleaning the Device

NOTICE

Do not use a cloth or any material that can scratch the optical lens on the front of the device. Scratching the optical lens may cause poor radar performance.

- Clear mud and dirt from the weather cap area.
- While the weather cap is closed, hold the device under running water.

After cleaning, allow the device to dry completely.

Radar Detection

WARNING

The device can improve situational awareness. It is not a replacement for cyclist attentiveness and good judgement. Always maintain awareness of your surroundings, and operate the bicycle in a safe manner. Failure to do so could result in serious injury or death.

- The radar detects approaching vehicles up to 140 m away.
- The radar detects approaching vehicle speed from 10 to 160 km/h (from 6 to 99 mph).
NOTE: The radar does not detect vehicles traveling at the same speed as your bike.
- The radar beam width is 40 degrees. It provides radar coverage for typical bends in the road.
- The radar can detect up to eight approaching vehicles.

Specifications

Varia eRTL615 Specifications

Operating temperature range	From -20° to 60°C (from -4° to 140°F)
Wireless frequencies	2.4 GHz @ 8 dBm maximum; 24 GHz @ 10 dBm maximum
Water rating	IEC 60529 IPX7 ¹
eRTL615 LED luminous flux	20 lm (solid mode) 8 lm (peloton mode) 29 lm (night flash mode) 65 lm (day flash mode)
Nominal power rating	DC ² 1.5W @ 12V
Power input	Power from the eBike or an external power source using a compatible eBike cable.

Varia RDU Specifications

Battery type	Rechargeable, built-in lithium-ion battery
Battery life	Up to 10 hr., typical usage
Operating temperature range	From -20° to 60°C (from -4° to 140°F)
Charging temperature range	From 0° to 45°C (from 32° to 113°F)
Wireless frequency	2.4 GHz ANT+ @ 0 dBm nominal
Water rating	IEC 60529 IPX7 ¹

Troubleshooting

Resetting the Device

You can reset the device if it stops responding.

From the device settings in the Varia app, select  > **Reset Device** > **Reset**.

Resetting deletes the pairing connections from the device.

Product Updates

On your computer, install Garmin Express™ (www.garmin.com/express).

This provides easy access to these services for Garmin devices:

- Software updates
- Product registration

¹ The device withstands incidental exposure to water of up to 1 m for up to 30 min. For more information, go to www.garmin.com/waterrating.

² The device will not work with AC power cables.

Updating the Software Using the Garmin Express Application

Before you can update your device software, you must download the Garmin Express application.

- 1 Connect the radar device to your computer using the USB cable.
Garmin Express looks for software updates automatically and sends them to your device.
- 2 Follow the on-screen instructions.
- 3 Disconnect the device, and connect it to your eBike or a USB power source.
The radar LED flashes blue and green to indicate the device is updating and may pause during the update. When the update is complete, the LED flashes green 10 times.

The radar device is not responding

During a ride, if the radar device status LED is solid red, the device is in an error state.

- Make sure the device is within the approved operating temperature range ([Varia eRTL615 Specifications, page 14](#)).
- Turn the device off, and turn it back on.
- Avoid multiple sources of radar interference.

My phone will not connect to the device

- Bring the device within range of your phone.
- If your devices are already paired, turn Bluetooth off on both devices, and turn it back on.
- If your devices are already paired, remove the Varia eRTL615 from the Bluetooth settings on your phone, and pair the devices again.
- If your devices are not paired, enable Bluetooth technology on your phone.
- On your phone, open the Varia app, select **+** to enter pairing mode.

Radar detection does not work indoors

The device is tuned to detect vehicles in an outdoor setting. If you turn on the device indoors, a saturation alert can occur. When you take the device outdoors, the device resumes normal operation.

The status LED is flashing yellow

If the device status LED flashes yellow while the tail light is on, the device is in demo mode. When the device is in demo mode, artificial data is generated for demonstration only.

To exit demo mode, select an option:

- Turn the device off, and turn it back on.
- Hold the button for 10 seconds to reset the device.
- Reset the device using the Varia app ([Resetting the Device, page 14](#)).

The status LED turns red while updating the software

- Check the USB cable, connectors, and ports for damage.
- Turn both devices off, and turn them back on.
- Make sure the device is within the approved operating temperature range ([Varia eRTL615 Specifications, page 14](#)).



The status LED turns red while plugged into a power source

- Make sure the device is plugged into the power source using the eBike cable instead of the USB cable.
- Check the USB cable, connectors, and ports for damage.
- Make sure the power source is generating power.
You can check this several ways. For example, you can check whether other devices powered by the source are functioning.
- Make sure the device is within the approved operating temperature range (*Varia eRTL615 Specifications, page 14*).

The radar device disconnects from the Edge bike computer

WARNING

If the radar device is not connected or sending radar data, Garmin recommends that you stop riding and check the devices in a safe location. Failure to do so could result in serious injury or death.

- Turn both devices off, and turn them back on.
- Pair the devices (*Pairing the Varia eRTL615 with Your Edge 1040, page 6*).
The Varia eRTL615 sends light and radar data to the Edge bike computer. The Edge bike computer displays  and  when connected.

The radar device disconnects from the Varia app

WARNING

If the radar device is not connected or sending radar data, Garmin recommends that you stop riding and check the devices in a safe location. Failure to do so could result in serious injury or death.

- Turn off Bluetooth technology from your phone settings, and turn it back on.
- Turn off both devices, and turn them back on.
The Varia eRTL615 sends light and radar data to the Varia app. The Varia app displays  when connected.

The radar device disconnects from the Varia RDU device

WARNING

If the radar device is not connected or sending radar data, Garmin recommends that you stop riding and check the devices in a safe location. Failure to do so could result in serious injury or death.

If the threat level LED is solid red and the REAR LED is off, the radar device is not connected to the Varia RDU device.

- Turn both devices off, and turn them back on.
You can check the battery level when you turn the devices back on.
- Pair the devices (*Pairing the Radar Device with the Varia RDU, page 11*).

Getting More Information

- Go to support.garmin.com for additional manuals, articles, and software updates.
- Go to buy.garmin.com, or contact your Garmin dealer for information about optional accessories and replacement parts.

