



Rider



500

User Manual

Table of Contents

Getting Started	4	Results	33
Rider S500 Key Functions	4	Settings	34
Reboot Rider	4	Bike Setup	34
Accessories	4	Display	37
Touch Screen	5	Pair Sensors	38
GUI Display	6	System	42
Quick Status	7	Altitude	45
Status Icons	8	About	46
Step 1: Charge Your Rider S500 ...	9	Profile	47
Step 2: Turn On Rider S500	9	Bryton Advanced Settings	48
Step 3: Initial Setup	9	Notifications.....	44
Step 4: Acquire Satellite Signals	10	Appendix	45
Step 5: Ride with Rider S500	10	Specifications	45
Step 6: Share Your Records	11	Battery Information	46
Firmware Update	13	Install Rider S500	48
Course	16	Install the Speed/Cadence/Dual Sensor (Optional).....	49
Route	15	Install Heart Rate Belt (Optional).....	50
Route Guidance	18	Wheel Size and Circumference	51
Reverse	18	Data Fields.....	52
Climb Challenge	20	Basic Care For Your Rider S500 ...	56
Workout	21		
Bryton Test	23		
Smart Trainer	24		
Navigation	27		
Voice Search	27		
Pin a Location	28		
Navigate on Bryton Active App	25		
Retrace	29		
Download Maps	30		

WARNING

Always consult your physician before you begin any training. Please read the details in Warranty and Safety information guide in the package.

Australian Consumer Law

Our goods come with guarantees that can not be excluded under the New Zealand and Australian Consumer Laws. You are entitled to a replacement or refund for a major failure and for compensation for any other reasonably foreseeable loss or damage. You are also entitled to have the goods repaired or replaced if the goods fail to be of acceptable quality and the failure does not amount to a major failure.

Video Tutorial

For a step-by-step demonstration of device and Bryton Active app, please scan the QR code below to check out Bryton Tutorial Videos.



<http://www.youtube.com/c/BrytonActive>

Getting Started

This section will guide you through basic preparations before the first use with your Rider S500.

Rider S500 Key Functions



A POWER/LOCK (⏻🔒)

- Long press to turn the device ON.
- Long press to turn the device OFF.
- Press to lock or unlock the screen.

B LAP (⏸)

- When recording, press to mark the lap.

C RECORD (●||)

- In Cycling mode, press to start recording.
- When recording, press to pause recording and enter the Menu.

D PAGE (≡)

- In Cycling mode, press to switch meter screen pages.

Reboot Rider

Press (⏻ / ⏸ / ●|| / ≡) at the same time to reboot the device.

Accessories

The Rider S500 T SKU comes with the following accessories:

USB Cable



Bike Mount



Sport Mount



Optional items:

Smart Heart Rate Monitor



Smart Speed Sensor



Smart Cadence Sensor



Touch Screen



- Swipe up from the very bottom of the screen to return to the Home Page from any screen.
- On the Lock screen, swipe up to unlock and return to the Home Page. Swipe left or right to switch data pages.
- In Cycling mode, swipe left or right to switch data pages.



- In meter page, long press to edit the cycling grid and scroll up and down to select desired cycling data.
- Select ✓ to confirm selection.
- Select ↶ to return to the previous page.



- In meter page, single tap to go to show the Quick Status page.



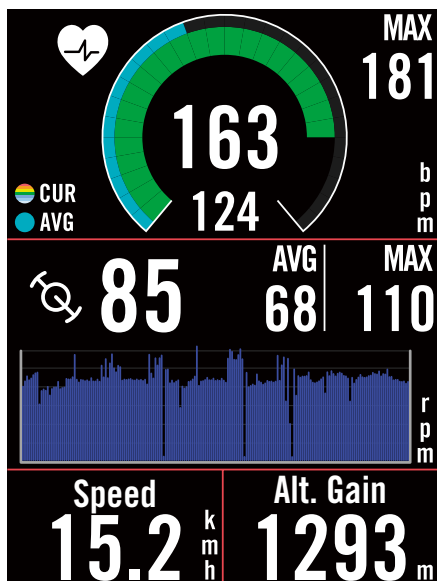





GUI Display



Outer Rings



	Average value
-----------------------------------------------------------------------------------	---------------

Inner Rings

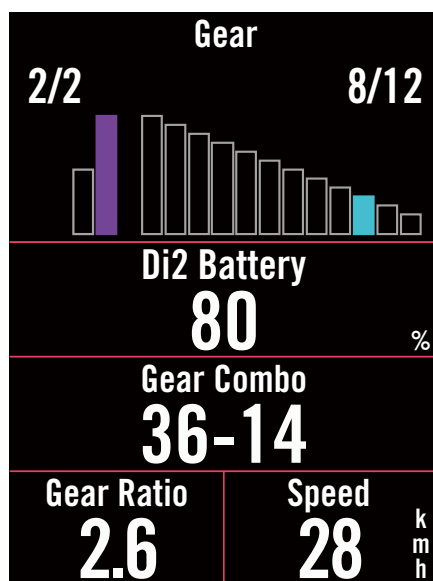







	Current value when using a Speed or a Cadence sensor.
	Current value when using a Heart Rate Monitor or a Power sensor. The colors will change by different zones, which are based on the settings.
	
	
	
	
	
	



Bar Chart for Di2/E-Shifting

	Value of the Cassette.
	Value of the Crankset.

Bar Chart for Connected Sensors

	Current value when using a Speed or a Cadence sensor.
	Current value when using a Heart Rate Monitor or a Power sensor. The colors will change by different zones, which are based on the settings.
	
	
	
	
	
	

NOTE:

- Please go to [page 55](#) to see more details for setting Heart Rate Zone and Power Zone
- Please go to [page 5](#) to see how to edit data grids in meter page. Select "Graph" in the grid category, if you want to display the data in graphic mode.
- Please go to [page 34](#) to see more information for data grids settings. Some page options including 8B, 9B, 10, 11, and 12 are not allowed to display graphics.



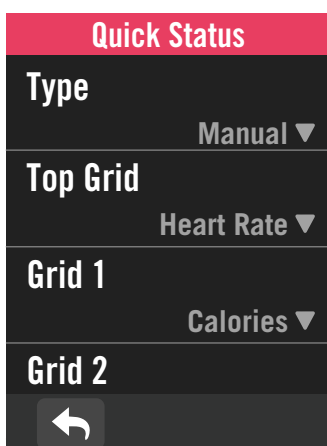
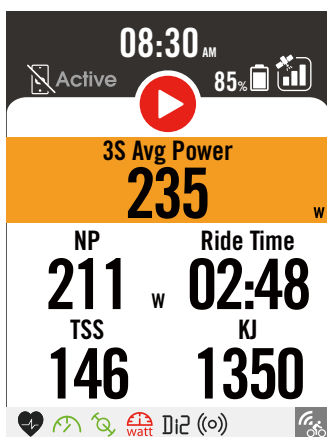
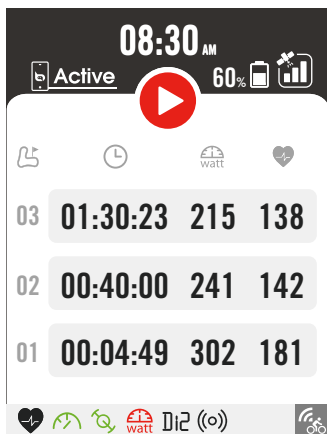

Quick Status

See key statuses while riding, such as sensor & smartphone connection, GPS signal, and individual battery status of paired sensor ,etc...Users can also see if device is recording at a glance by the flicker.





1. Single-tap the screen on meter page to open the Quick Status menu.
2. The recording icon will flicker with red and gray flashes while the device is recording.
3. You can customize the quick status by selecting different data for each grid. Tap  in the home page > **Bike Settings** > **select a bike profile** > **Ride Config** > **Quick Status**.
4. Color of the top grid will change by different zones, which are based on the settings.



Recording Status

	Recording Pause
	Stop / Not Recording
	Recording

Sensors Battery Status

	Critical
	Good
	New

Active App connecting Status

 Active	Connected
 Active	Disconnected

NOTE:

- Only paired sensors will show on the Quick Status Menu.
- If there is no battery icon next to the sensor names, it means that the sensor has no signal.
- Please see [page 35](#) to see the settings for Quick Status.



Status Icons

Icon	Description
GPS Signal Status	
	Unable GPS
	GPS Off / No Signal (not fixed)
	Weak Signal
	Strong Signal
	GPS Data Saved
Power Status	
	Full battery
	Out of battery
	Battery Charging
Record	
	Recording
	Recording Paused
	Not Recording
	Recording Stopped
Homepage	
	Profile
	Settings
	Result

Icon	Description
Navigation	
	Route
	History
	Favorite
	Zoom in
	Zoom out
	Locate Current Position
	Voice Search
	Add a PIN
	Search POI
	Move the Map
	Compass Mode
	Heading Mode
	Stop Navigating
	Route Starting Point
	Route Ending Point
	Route Distance
	Climbs Info

Icon	Description
Sensor Pairing	
	Heart Rate Sensor
	Speed Sensor Active
	Cadence Sensor
	Combo Sensor
	Power Meter Active
	D12
	Electronic Shifting
	Bike Radar
	Smart Trainer
	E-Bike (LEV)
	E-Bike (Shimano)
Other	
	Trainer Passive Mode
	Switch Training Zones
	Saved Workouts/Location
	Lap Information
	Live Track

NOTE: When you see this for the GPS signal, it means the device is keeping the ephemeris data, which will help the device acquire the GPS signal faster. The data will remain in 1 to 2 weeks, and needs to be updated.



Step 1: Charge your Rider S500

Charge the Rider S500 battery for at least 4 hours. Unplug the device when it is fully charged.

- You may see the battery icon  blinking when the battery is very low. Keep the device plugged in until properly charged.
- The temperature suitable for charging battery is 0°C ~ 40°C. Beyond this temperature range, charging will be terminated and the device will draw power from battery.

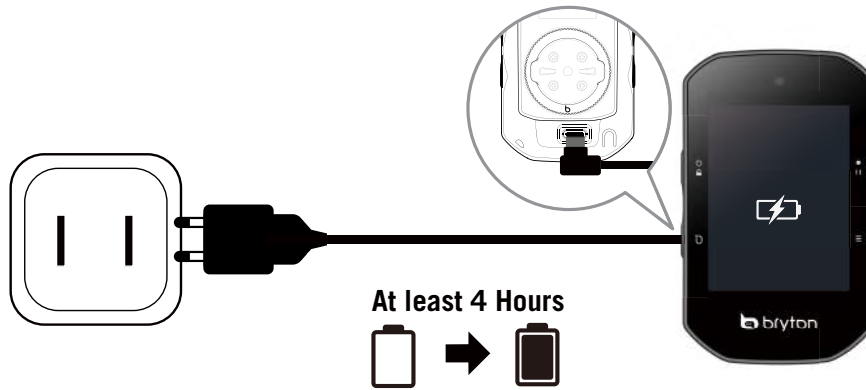

Step 2: Turn On Rider S500

Press  to turn on the device.

Step 3: Initial Setup



When powering on the Rider S500 for the first time, follow the instruction to complete setup.

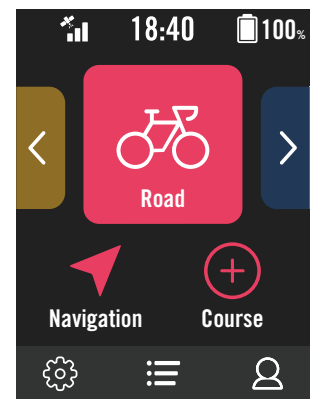
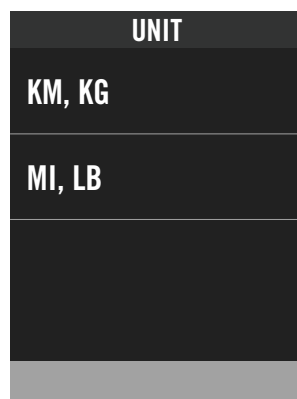
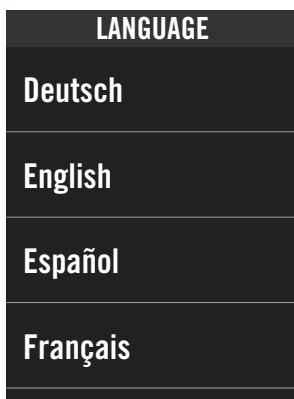

1. Select the display language.
2. Choose the units of measurement.
3. Download Bryton Active app and pair the Rider S500 with your cellphone.
4. Go through the starting tutorial before riding.



Step 4: Acquire Satellite Signals

Once the Rider S500 is turned on, it will automatically search for satellite signals. It may take 30 to 60 seconds to acquire signals for first time use.

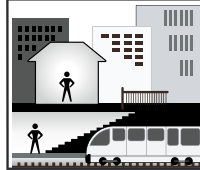
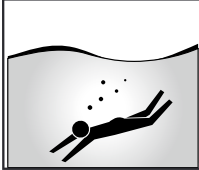
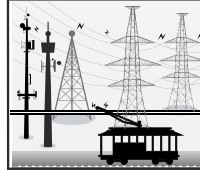



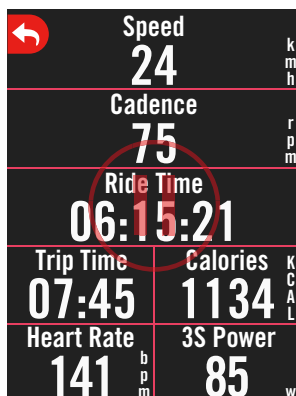
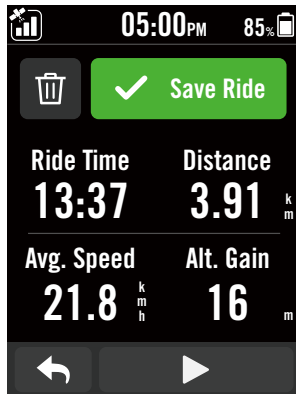

- The GPS signal Icon ( / ) appears when GPS is fixed.
- If GPS signal is not fixed, a  icon appears on the screen.
- If GPS function is disabled, a  icon shows on the screen.
- Please avoid obstructed environments since they might affect GPS reception

				
Tunnels	Inside rooms, building, or underground	Underwater	High-voltage wires or television towers	Construction sites and heavy traffic

Step 5: Ride with Rider S500

After the “Satellite Acquired” message pops up, enter the Bike 1, Bike 2 or Bike 3 cycling page and enjoy your ride in free cycling mode.



- **Free ride (without recording):**
In cycling mode, measurement starts and stops automatically in sync with the movement of the bicycle.
- **Start an exercise and record your data:**
 1. In cycling mode, press  to start recording, press  again to pause recording.
 2. Choose to **Discard** or **Save** the result to end riding.
 3. Choose  to go to the meter page to see your cycling data. Then tap on  to go back to the previous page.
 4. Tap on  or press  to continue recording.
 5. Rider S500 supports continuing to record when the ride was interrupted. Even turning off the computer, you can still continue recording after turning on the computer.



Step 6: Share Your Records

Connect Rider S500 to PC

- a. Connect Rider S500 to PC by using Bryton's original USB cable.
- b. The folder will popup automatically or find the "Bryton" disk in the computer.

Share Your Tracks to Brytonactive.com

1. Sign up on Brytonactive.com

- a. Go to <https://active.brytonsport.com>.
- b. Register for a new account.

2. Connect to PC

Turn on your Rider S500 and connect it to a computer by USB cable.

3. Share Your Records

- a. Click "+" in the right upper corner.
- b. Drop FIT, BDX, GPX file(s) here or Click "Select files" to upload tracks.
- c. Click "Activities" to check uploaded tracks.

Share Your Tracks to Strava.com

1. Sign up / log in on Strava.com

- a. Go to <https://www.strava.com>
- b. Register for a new account or use your current Strava account to log in.

2. Connect to PC

Turn on your Rider S500 and connect it to your computer by USB cable.

3. Share Your Records

- a. Click "+" on the top right corner of the Strava page and then click "File".
- b. Click "Select Files" and select FIT files from Bryton device.
- c. Enter information about your activities and then click "Save & View".

Auto Sync Tracks to Bryton Active App

No more uploading tracks manually after riding. Bryton Active App automatically syncs your track after pairing with your GPS device.

Sync via BLE

a. Scan QR code below to download Bryton Active App or go to Google Play/App Store to search Bryton Active App. Then, log in or create an account.



<http://download.brytonsport.com/inst.html>

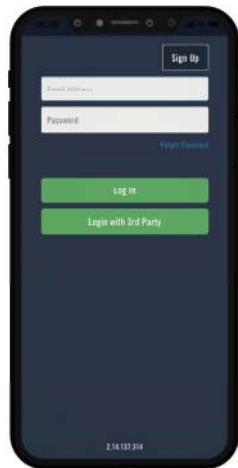

b. Go to Settings > Device Manager > + > Rider S500 to add your GPS device.



c. Check if the UUID shown on app is as same as your device. Select “Yes” to confirm adding this device. If the UUID does not match, press NO and try again.



d. Successfully added! Turn on Auto Sync Tracks. Now new tracks will be automatically uploaded to Bryton Active App..



NOTE: Bryton Active App syncs with Brytonactive.com. If you already have a brytonactive.com account, please use the same account to log in to Bryton Active App and vice versa.

Firmware Update

Bryton Update Tool

Bryton Update Tool is the tool for you to update GPS data, firmware and download Bryton Test.

1. Go to <http://www.brytonsport.com/#/supportResult?tag=BrytonTool> and download Bryton Update Tool.
2. Follow the on-screen instructions to install Bryton Update Tool.

Update GPS Data

The newer GPS data can speed up the GPS acquisition. We highly recommend you to update GPS data for every 1-2 weeks.

Update Firmware

Bryton releases a new firmware version with new functions or on irregular basis to add new functions or fix bugs. We highly recommend that you update firmware once the latest version is available. It usually takes a while to download and install firmware for updating. Do not remove USB cable during updating.

Update via Active app

You can choose to update the firmware via bluetooth or with a Bryton USB cable.

For iOS phone

a. Connect the Rider S500 to your phone via Bluetooth.



b. The update message will pop up automatically, select **OK** to start the update. Or select **Firmware Update** to start updating.

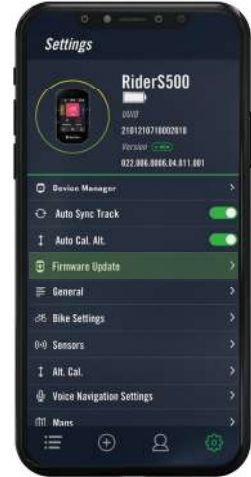

c. Choose to update the firmware with the Bryton cable or Bluetooth. You will need a [USB-C to USB Adapter](#) with Bryton original cable. Make sure the smartphone is connected to the device. Select the **“BRYTON”** root folder to allow Bryton Active app gets permission to access the device for downloading new firmware.

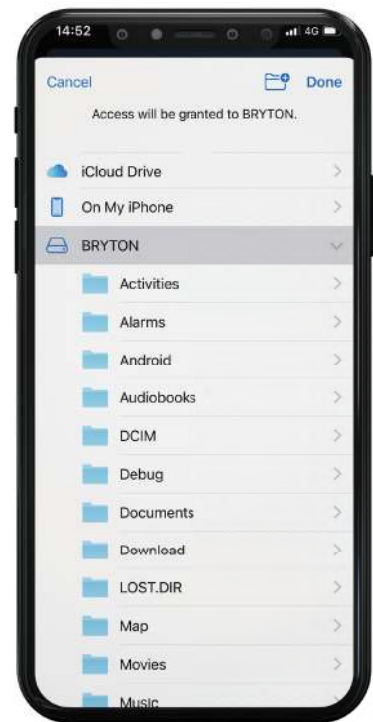
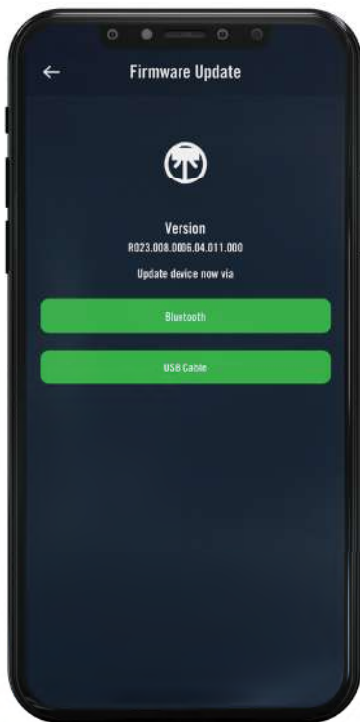

For Android phone

a. Connect the Rider S500 to your phone via Bluetooth.



b. The update message will pop up automatically, select **OK** to start the update. Or select **Firmware Update** to start updating.

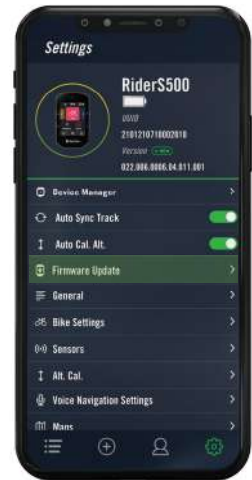

c. Choose to update the firmware with Bryton cable or with Bluetooth. If you are using the cable, please give the app permission to access phone storage.

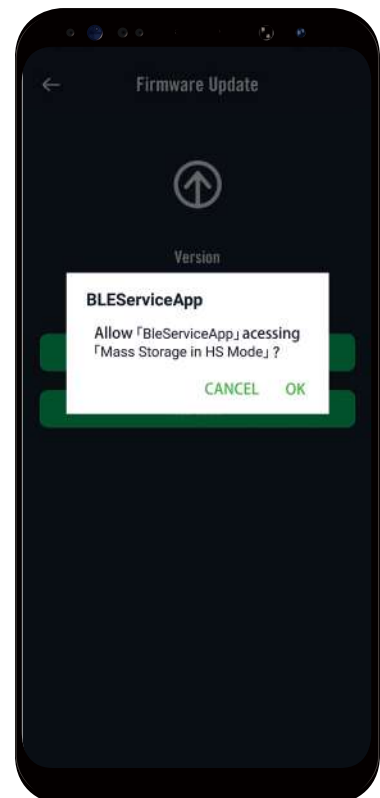
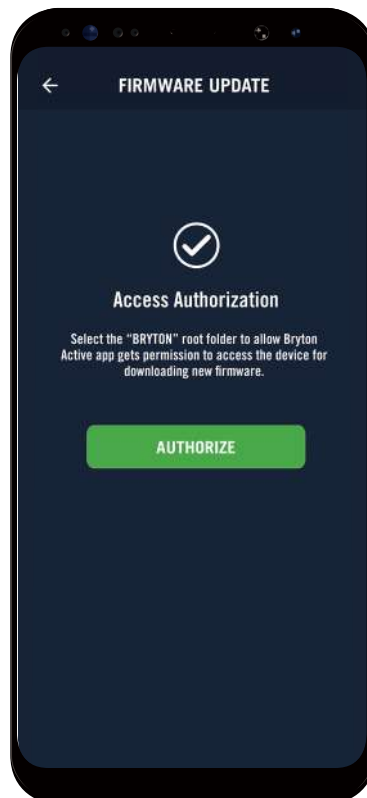
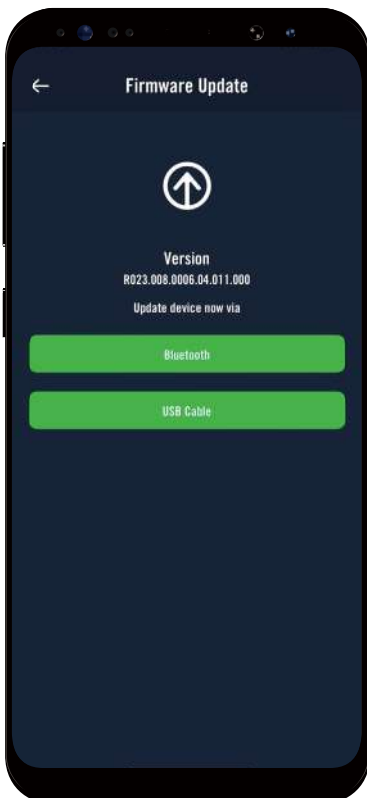

Course



Route

Create Track

Rider S500 provides 3 ways to create tracks: 1. Plan trip via Bryton Active App. 2. Import routes from 3rd party platforms. 3. Auto sync routes from Strava, Komoot and RideWithGPS.

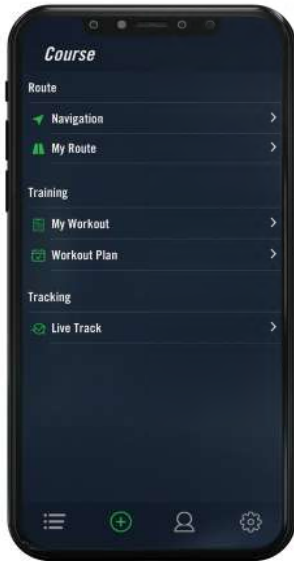
Plan Trips via Bryton Active App



1. In Bryton Active App, select **Course** > **My Route** > **+** > **Plan trip** to set a Start point and Destination by tapping on the map or inputing address in left Search Bar.
2. Download the planned trip to **My Route** by tapping on the  icon .
3. Go to **My Route** and select the route. Click the ... in the upper right corner to download the route to your Bryton device.
4. In the Device Main Menu, navigate to **Course** > **Route**, find the route and tap on  to start following the track.

Import routes from 3rd-Party Platforms

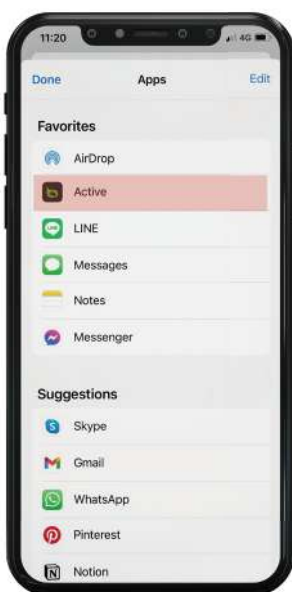

1. Download routes in gpx file from 3rd party platform.
2. Select **Open in Active** (for iOS) or **Open files with Bryton Active App** (for Android).
3. Select **Course** > **My Route** in Bryton Active App.
4. Here you can see the routes imported to the App.
5. Select the upper right icon ... to download the route to your device.
6. In the Main Menu of the device, navigate to **Course** > **Route**, find the route and tap on  to start following the track.



Auto Sync routes from Strava, Komoot, RideWithGPS

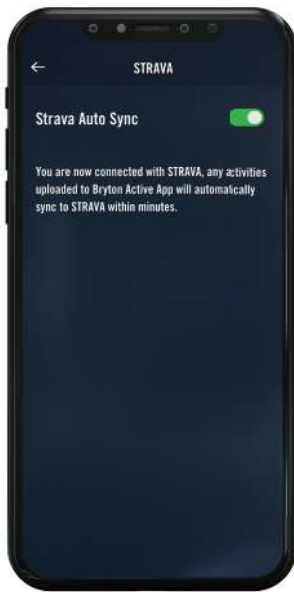

1. Enable STRAVA / Komoot / RideWithGPS auto sync in the **Course** tab to establish a link with the Bryton Active app.
2. Create/modify routes in these platforms and save them as public.
3. Go to **My Route** and select the route. Click the ... in the upper right corner to download the route to your Bryton device.
5. In the Main Menu of the device, navigate to **Course > Route**, find the route and tap on ► to start following the track.

Add POI

After setting up your POI and Peak info, you can check the distance to your next POI or Peak in Route mode, allowing you to make the right decision based on your status and stay motivated along the way.

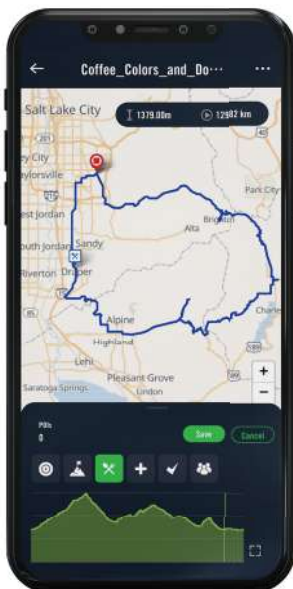

1. Go to **Course > My Routes** in Bryton Active App.
2. Select the route you would like to add POIs.
3. Press **POI** at the bottom, then click **+ Add POI**.
4. Choose a POI type by selecting the icon. Slide your finger on the bar below to place the POI anywhere along your route.
5. Press save and name the POI after confirming the position.
6. Click the ... in the upper right corner to download the route to your Bryton device.
7. In the device Main Menu, find **Course > Route**. Find the planned route and press ► to start following the track.

Note:

1. Please connect the device with your smart phone before downing the route to the device.
2. To view on-device POI info, please add the related POI data fields to the data pages. It is also recommended to put these data fields in larger grids to see complete information.



Route Guidance

After downloading routes to the Rider S500, you are able to follow the route guidance. Rider S500 supports advanced features to help you stay on track and get the most out of your rides, such as auto-rerouting, on-screen POIs, and reverse saved rides.

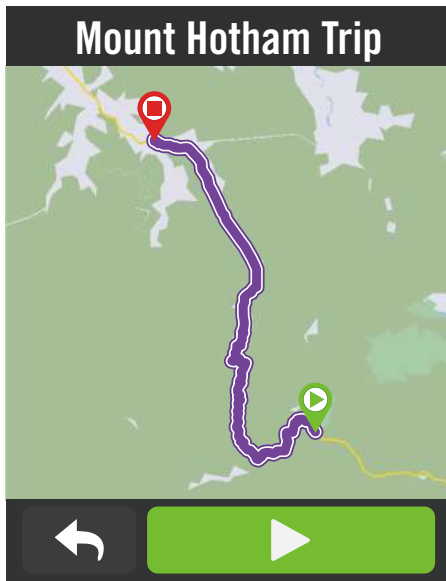

1. Select **Course > Route**, then Find the planned route in the list.
2. Press ► to start riding.

Reverse Route

Simply upload any Bryton Active, Strava, Komoot or any other 3rd party route to your Rider S500 and reverse the route, swapping the start and end points and other guidance so you can follow a route any way you want to!



1. Select **Course > Route**, then select a disred route in the list.
2. Swipe to the bottom of the page and press **Reverse Route**.
3. Press ► to start the navigation.



Navigate to the Starting Point

While strating a route guidance, the Rider S500 will lead to the route or the starting point if you're not the route path.

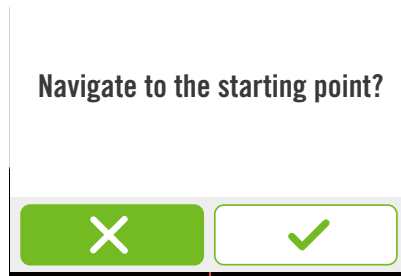

Connected to Bryton Active App

When the Rider S500 is connected to the app, it will generate a path to the route.

Press ✓ to nvigate to the start.

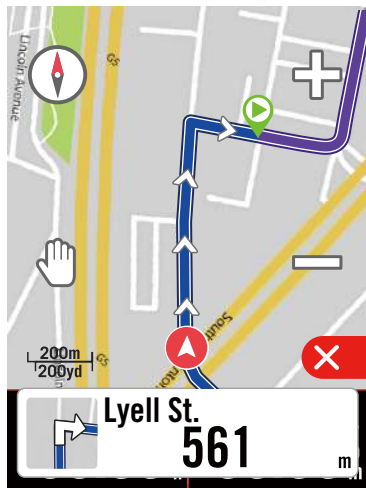

Press ✕ to nvigate to the closest path of the route.

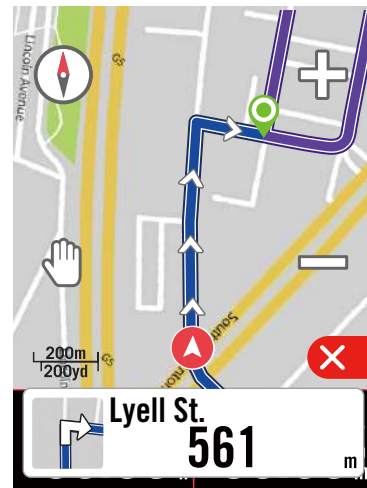

Without connection with Bryton Active App

If the Rider S500 is not connected to the app, the map will display a dash line to show you the direaction to the route.

Press ✓ to show the directin to the start.

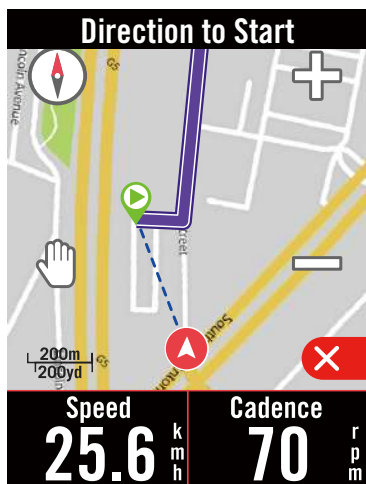

Press ✕ to display to the closest path of the route.

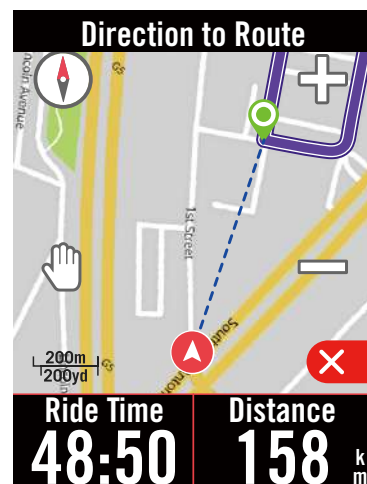

Climb Challenge

Climb to new heights with the Climb Challenge feature. When approaching a climb, the Rider S500 will change to the Climb Section page, providing an overview of a route's climb segments. The Climb Challenge screen also features a graphical summary with multiple climbs, vivid color climb segments, distance, altitude & ascent, and start & end points, providing easy access and ride information at-a-glance.

You can setup the climb challenge page in the **Settings > Bike Settings > select a bike profile > Ride Config**. Choose to automatically or manually display the page while riding.

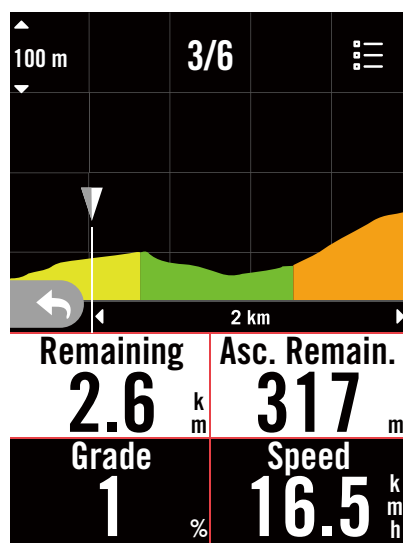
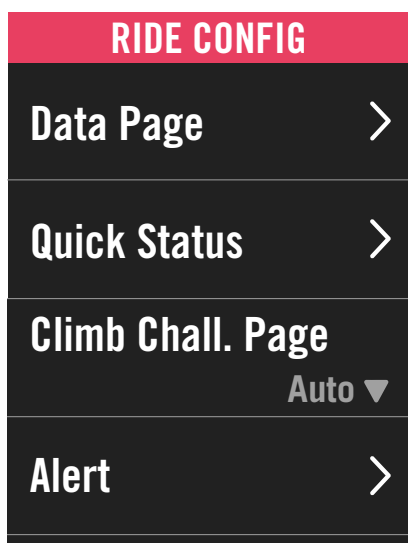

You can also check the climbs information in the saved route. Go to **Course > Route > select a disred route > Climbs**.

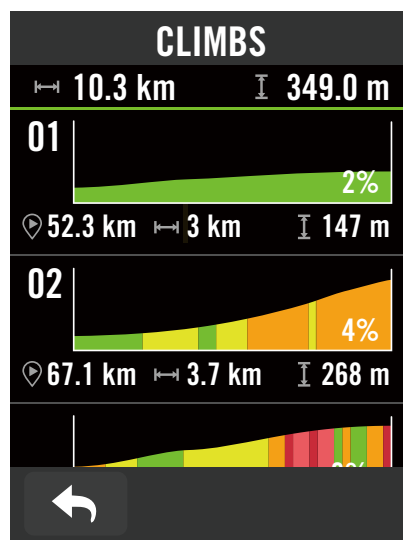
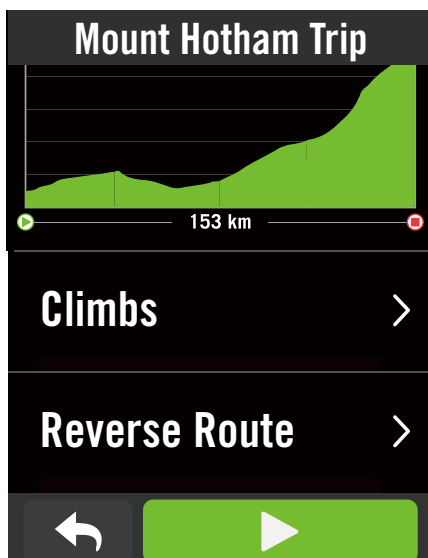

Workout

Create a Workout

Rider S500 provides 2 ways to create workout: 1. Plan workout via Bryton Active App.
2. Import workout from 3rd party platforms.

Plan workout via Bryton Active App



1. In Bryton Active App, select **Course** > **My Workout** > **“+”** > **Plan Workout** to plan a training workout by selecting interval types and enter details.
2. Select a workout and click **“...”** in the top right to download the workout to the device.
3. You can also plan workouts for a long period by selecting **Course** > **Workout Plan** > **“+”** to copy from existing workout or plan a new workout for different dates.
4. Click **“...”** in the top right to sync the workout plan for the next 7 days.

Import workout from 3rd party platforms



1. Create a workout plan on TrainingPeaks website.
2. Enable TrainingPeaks auto sync in the Course tab or in **My Workout** > **“+”** > **3rd party account link** to establish a link with the Bryton Active app.
3. Or you can also add workouts on the calendar from My Workout by entering **Course** > **Workout Plan** > **“+”**, click **Copy from My Workout** and select the desired workouts.
3. Click **“...”** in the top right to sync the workout to the device for the next 7 days.



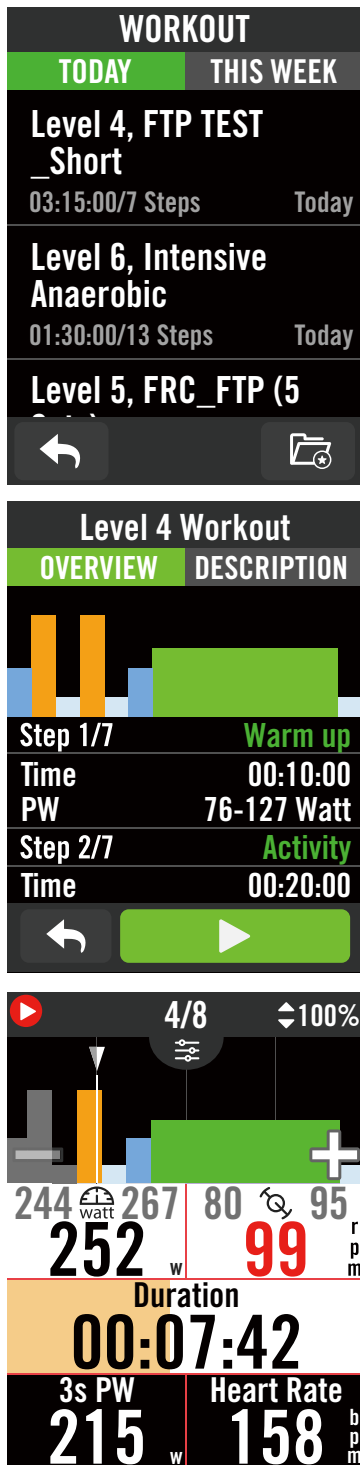

Train with a Workout plan





1. Select **Course** in the home page.
2. Select **Workout**.
3. You can see the workout plans, which are synced from the app. Or select  to view all the workouts that you have saved.







Delete Workout

1. To delete the workout, click  then select the workout(s) and click  again to delete.
2. Select  to confirm.

Start Workout

1. Select the workout you would like to start with.
2. Select  to be ready for the workout, then press  button to start the workout.

Stop Workout

1. Press  to pause workout, then select  to return to workout or select  to save the record or click  to delete the record.
2. Choose  to go to the meter page to see your cycling data. Then tap on  to go back to the previous page.







Note: After you synced the workout plan from the app for the 7-day period, the workouts will disappear when the date passed. If you want to save a particular workout to the Rider S500, please download the workout from the app to the device.

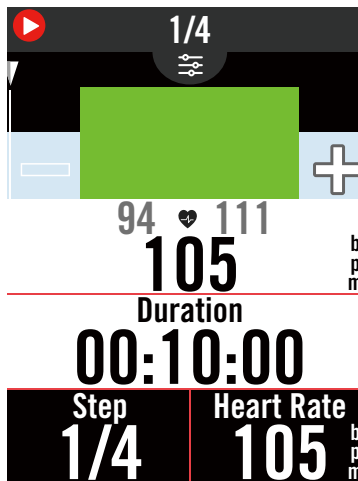
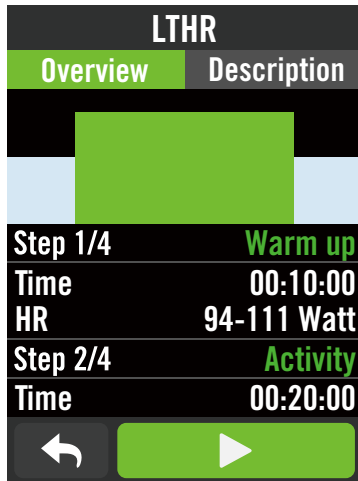

Bryton Test

Bryton Test includes test courses to help you evaluate your MHR, LTHR, FTP and MAP. Knowing your MHR, LTHR, FTP and MAP gives you a benchmark of your overall efficiency. It also helps you check progress over time and analyze your exercise intensity.



1. Press **Courses** in the home page.
2. Find **Workout**, tap on 
3. Click **Bryton Test** Select a test type and start testing.
4. Press  to skip to the next section.
5. Press  to pause workout.
6. Select  or **Save** the result to end the Bryton Test.
8. Choose  to go to the workout page to see your data. Then tap on  to go back to the previous page.
9. Tap on  to continue testing.

Smart Trainer

Set up a Trainer

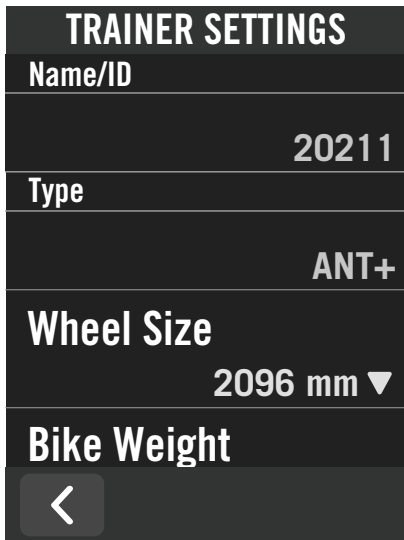

1. Select **Course** in the home page.
2. Find **Smart Trainer**
3. Tap **+** to connect a smart trainer to Rider S500.

Edit Information

1. After connected smart trainer to the Rider S500, it will switch to the **Smart Trainer** page.
2. Go to **Trainer Settings** to enter Wheel Size, Gear Ratio, and Bike Weight to set up a smart trainer profile.

Remove Trainers

1. Go to **Trainer Settings**.
2. Tap **Remove** then click **✓** to confirm.
3. If you stop paddling for a while, the smart trainer will automatically disconnected.

Virtual Ride

In Virtual Ride, Rider S500 will work seamlessly with most smart trainers and can simulate planned routes from the Bryton Active App.

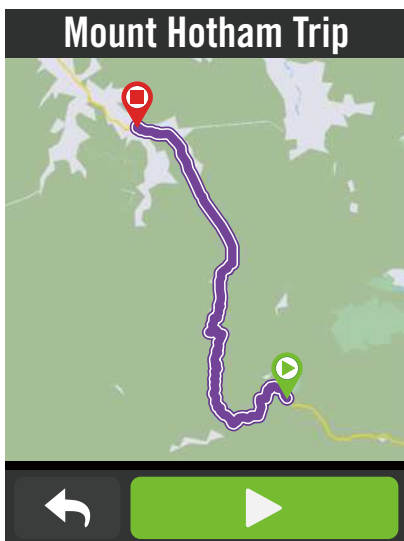

1. Select **Course** in the home page.
2. Select **Smart Trainer > Virtual Ride**.
3. You can view all the planned routes that you have downloaded on the device.

Ride on a Route

1. Select the route you would like to start with.
2. Tap on **▶** to start riding.

End Virtual Ride

1. Press **✕** to stop the ride.
2. Select **Save** to save the record.
3. Select **Discard** to discard the record.
4. Select **✓** to confirm.

Delete Routes

1. To delete the route, click **🗑** and select routes you would like to remove.
2. Select **✓** to confirm.

Note: To see how to create tracks: 1. Plan trip via Bryton Active App. 2. Import routes from 3rd party platforms. 3. Auto sync routes from Strava, Komoot and RideWithGPS. Please go to [Page16](#).



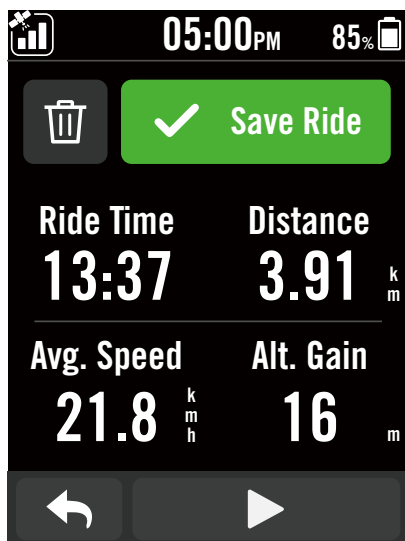
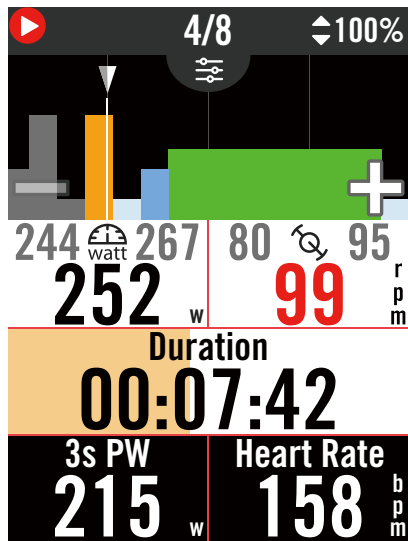

Smart Workout

Training plans can be built with the Bryton Active App and downloaded directly to the Rider S500. With ANT+ FE-C support, the Rider S500 will communicate with your smart trainer to simulate the resistance from the training plan.





1. Select **Course** in the home page.
2. Select **Smart Trainer > Smart Workout**.
3. You can see the workout plans, which are synced from the app. Or select  to view all the workouts that you have saved.







Delete Workout

1. To delete the workout, click  then select the workout(s) and click  again to delete.
2. Select  to confirm.

Start Workout

1. Select the workout you would like to start with.
2. Select  to be ready for the workout, then press  button to start the workout.

Stop Workout

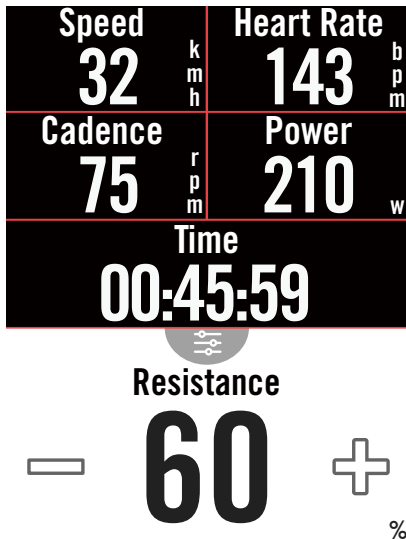

1. Press  to pause workout, then select  to return to workout or select  to save the record or click  to delete the record.
2. Choose  to go to the meter page to see your cycling data. Then tap on  to go back to the previous page.

Resistance





1. Select **Course** in the home page.
2. Select **Smart Trainer > Resistance**.

Start Resistance Workout

1. Switch to different zones by tapping  or adjust resistance level by clicking **+ / -**.
2. Select  to start training.
3. Resistance training will automatically stop once you start Virtual Ride or when the Smart Trainer lost connection.

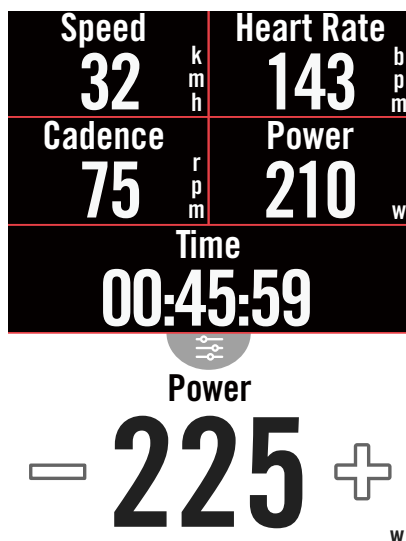
Power



1. Select **Course** in the home page.
2. Select **Smart Trainer > Power**.
3. Switch to different zones by tapping  or adjust resistance level by clicking **+ / -**.
4. Tap on  to start training.
5. Power training will automatically stop once you start Virtual Ride or the Smart Trainer lost connection.

Note: You need to connect a smart trainer to the Rider S500 before having access to the Virtual Ride, Smart Workout, Resistance, and Power Workout.

Navigation

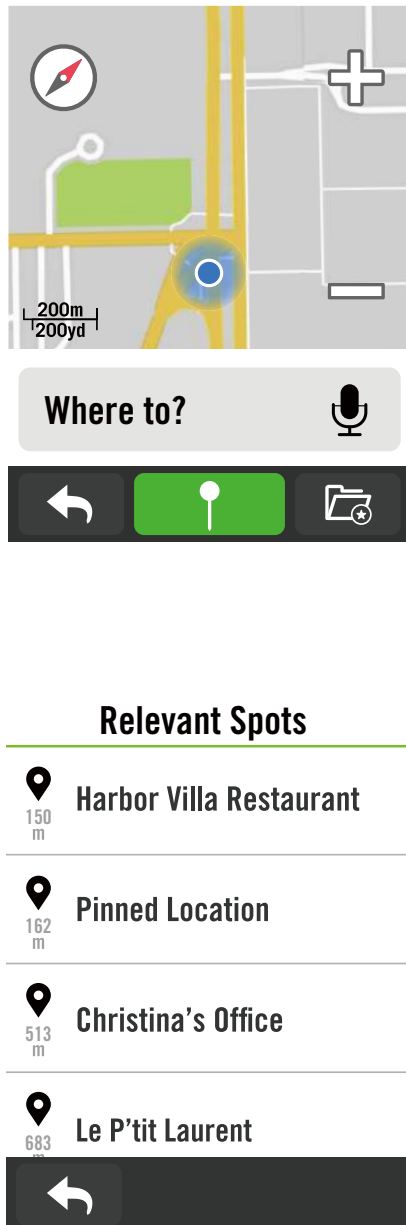

With connection to the internet, you can use your voice to search for locations on the Rider S500 in over 100 languages. The voice search features offers a faster, more intuitive and more convenient to find addresses or POIs.

Voice Search





1. Select **Navigation** in the home page.



Search Location by Voice Search

1. Tap the icon  to activate voice search.
2. Single tap on the icon  and say keywords, names, or addresses of a desired location.
3. Tap the middle icon again to stop receiving voice.
4. After processing search, pick the most relevant spot.

Adjust to More Accurate Position

1. After choosing a relevant spot, tap and hold on blank space to move the map for an accurate location.
2. Use  /  to adjust map size.

Generate a Route

1. Click  to view the route to your destination.
2. Tap on  to start navigation.

Pin a Location

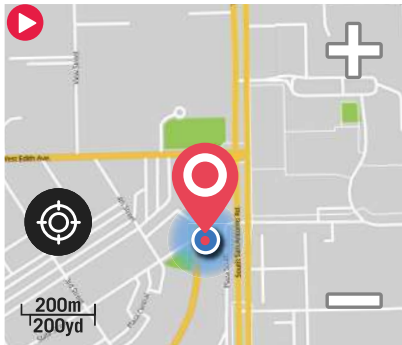

Move the map to pin the position you want.





1. Select **Navigation** in the home page.



Locate Your Current Position

1. Before locating your position, make sure you locate satellite.
2. Tap on  to locate your current position.

Navigate by Dropping a Pin



1. Select  and manually pin a desired spot on the map.
2. Tap and hold on blank space to move the map for accurate location.
3. Use  /  to adjust map size.

Generate a Route

1. Select  to view the direction to your destination.
2. Tap on  to start navigation.

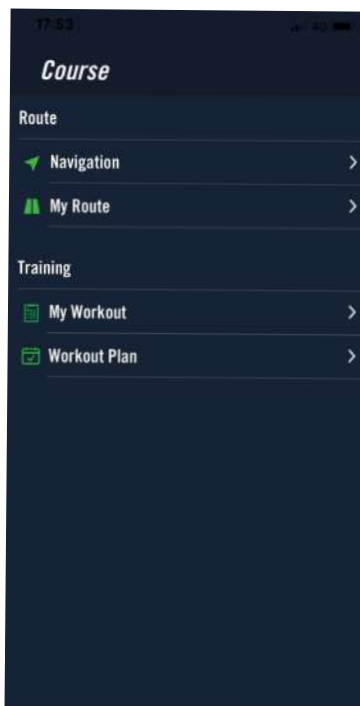
Navigate on Bryton Active App



1. Pair the Rider S500 with Bryton Active App, select **Course > Navigation**.
 2. Input keywords or address or POI type in the search bar then click .
 3. Select a result from the search list.
 4. Confirm the location then click **Navigate** to see the route.
 5. Click  in the top right to download the route to the device to start the navigation.
- Go to **My Route** and select the route. Click the **...** in the upper right corner to download the route to your Bryton device.



Retrace

When you want to return back to your starting location, the Rider S500 can help you double back with just a press of a button at any point during a ride, using the same path you took to retrace your steps and providing turn-by-turn route guidance!

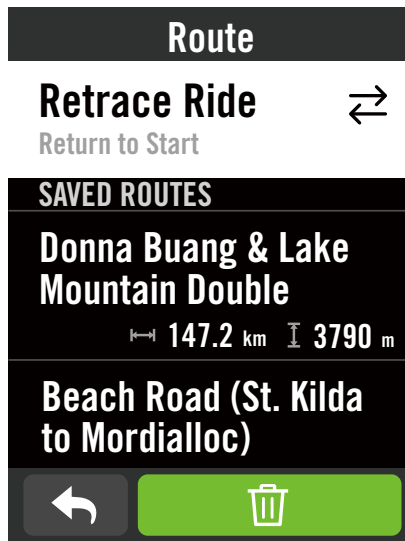

1. During navigating, swipe up to return to the **Home Page**. Go to **Course > Route > Retrace Ride**.

2. The device will generate a route for leading you back to the starting point via the exact same path you took at first. Follow the arrows to the right direction.

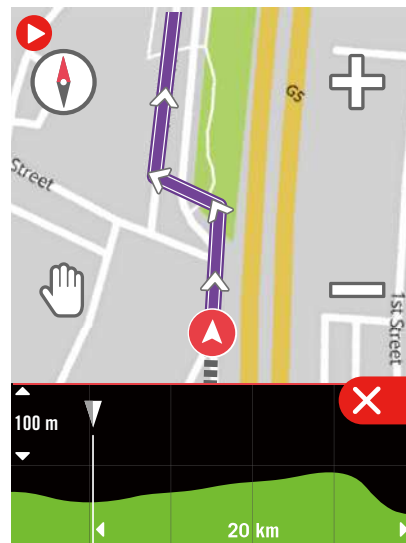
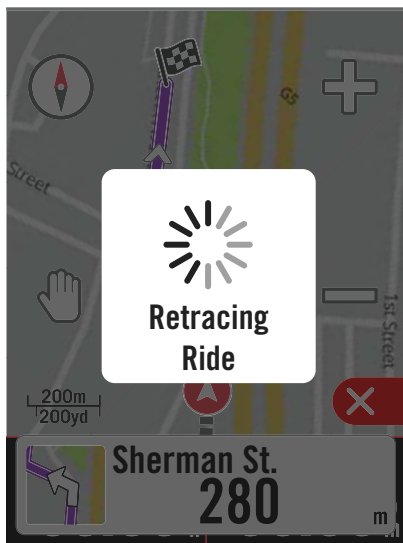

Note:

1. You need to start recoding a ride before using retrace feature.
2. You can choose to pause or not to pause recoding when you want to active retrace route.



Download Maps

The Rider S500 comes with preloaded maps of major regions around the world.

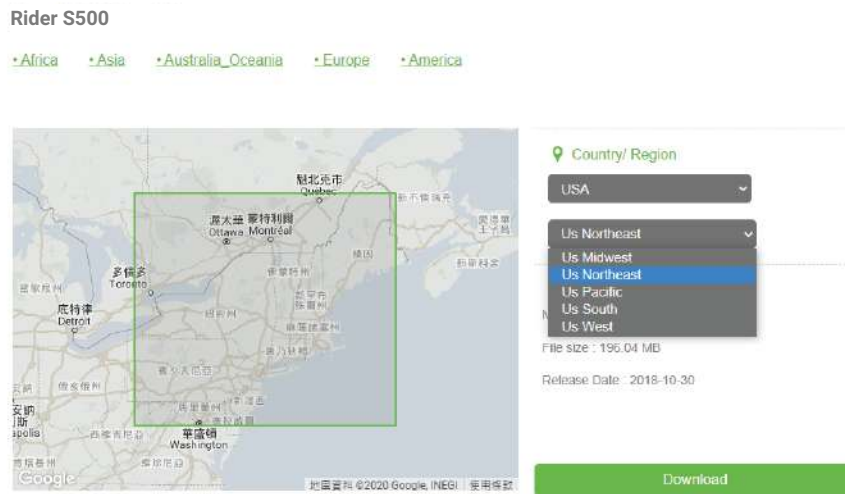

1. Download the desired map zip file from the official Bryton Website. Please unzip it. Please do not rename the file(s) or change the file extension(s) in the unzipped folder, as this may cause errors to occur.
2. Using the Bryton device's original USB cable, plug the device into the PC and in the "Bryton" disk, navigate to [Bryton>MAP].
3. Copy the unzipped folder and paste in the [Bryton>MAP>Update] folder.
*If there is not enough free space on the device to add the map(s), please remove unnecessary map folders are stored in the following locations: [Bryton>MAP>Update] & [Bryton>Map>MapData]. After adding the map file(s), please ensure that the device still retains at least 100MB of storage space in order to operate properly.
4. After the map file(s) has been successfully added to the device, go to the [Bryton>MAP>Data] folder and delete all of the contents and folders (these will repopulate after first system start-up).
5. Unplug device and power on, allowing device to acquire satellite connection for a few minutes. The map should then successfully load and appear on the device.



Download Maps Via Active App

a. Go to Settings > Maps.



b. Connect the device to your smart phone with Bryton USB-C cable. You will need a [USB-C to USB Adapter](#) while using an iPhone.

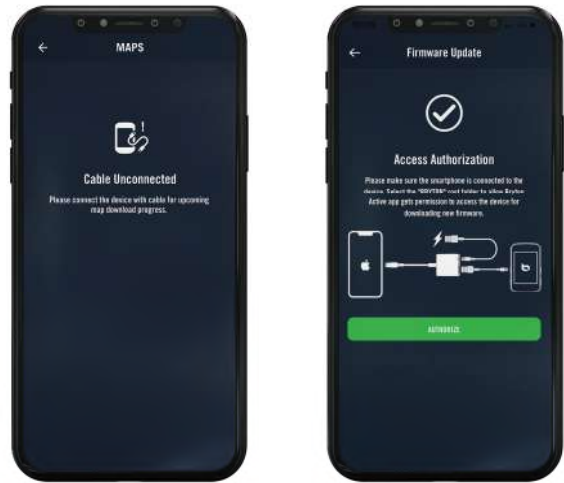

c. Select the “BRYTON” root folder to allow Bryton Active app gets permission to access the device for downloading maps.



d. Select the “Add Maps” and choose a desired map to download to the Rider S500.

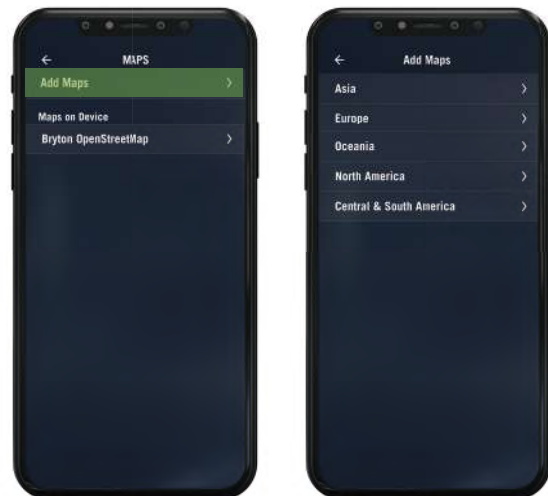

Delete Maps on the Ride S500

a. Go to Settings > Maps.



b. Connect the device to your smart phone with Bryton USB-C cable. You will need a [USB-C to USB Adapter](#) while using an iPhone.



c. Select the “BRYTON” root folder to allow Bryton Active app gets permission to access the device for downloading maps.

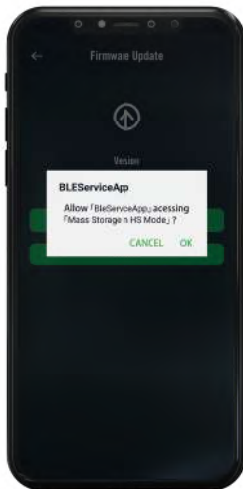

d. Select the “Bryton OpenStreetMap” and choose the map, which you want to delete.

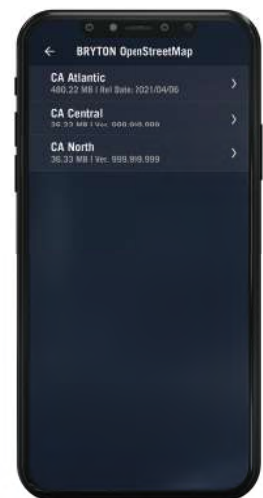
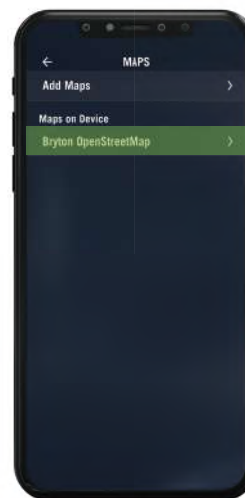

Results

You can view recorded activities on the Rider S500 or delete records to save more storage capacity of the device.

View Records

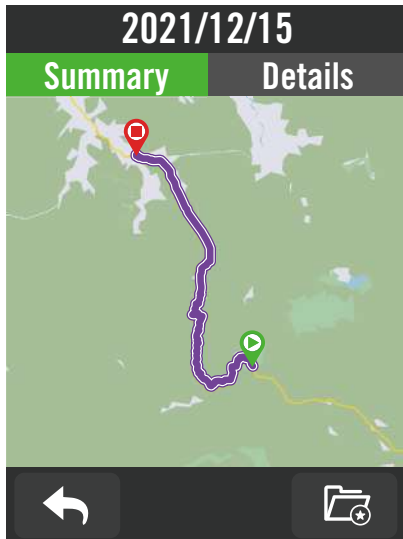

1. Select ☰ in the home page.
2. Pick a record to view details.
3. Tap **Details** or **Summary** to see different data.

Edit Record

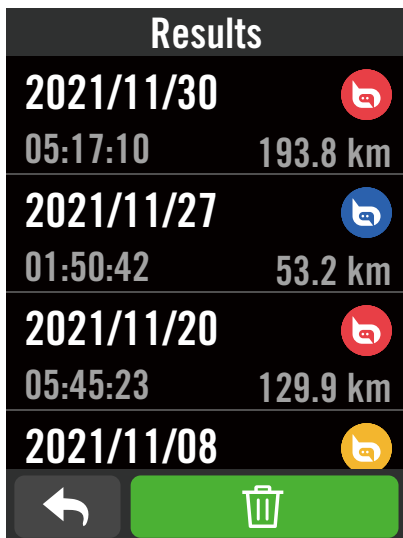

1. Select ☰ in the home page.
2. Tap on 🗑️ to enter the delete page.
3. Choose the record(s) then tap 🗑️ to delete the record.
4. Press ✓ to confirm.

Settings

In Settings, you can customize Bike settings, Brightness, Data Sync, Sensors, Notification, System, Altitude, Navigation settings, and Network. You can also find firmware information in this section. In addition, most used device settings are allowed to be personalized via Bryton Active App.

Bike Setup

Rider S500 supports up to 3 bike profiles, it is easier than ever to customize your device for any type of setup. Settings for each profile can be completely customized for any type of cycling, such as GPS system, wheel size, data fields, etc.

Ride Config

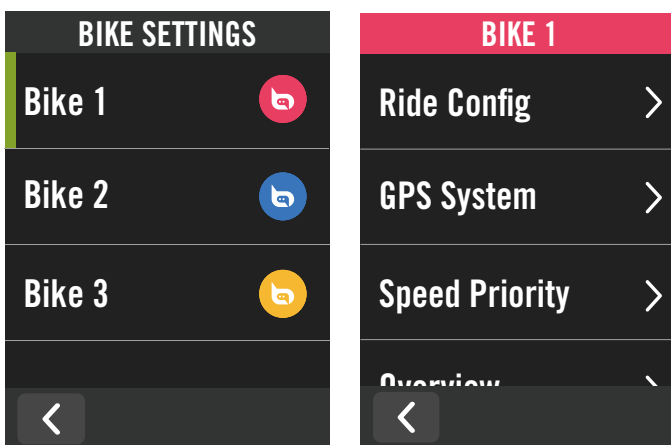

1. Select  in the home page.



2. Select **Bike Settings**.

Edit Ride Config

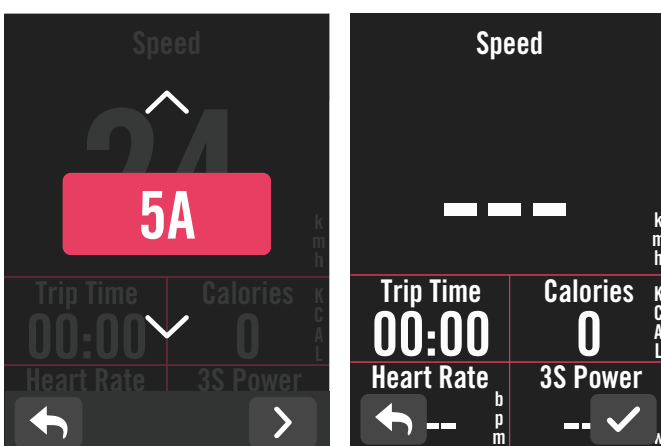
Select Bike 1 or Bike 2 or Bike 3 to view or edit more settings.



Data Page:

- Turn on data pages and click a page to modify grids numbers.
- In order to show graphics on the data page, the height of the desired data field must be at least one-third of the screen or larger.
- Press  to preview data fields. Tap  to confirm or  to go back.

Note: You can also edit bike profiles on Bryton Active app after paired it with the device. Go to Settings > Bike setting in the app. All the revised information will automatically sync to the device once you make sure the Rider S500 is connected to the app.



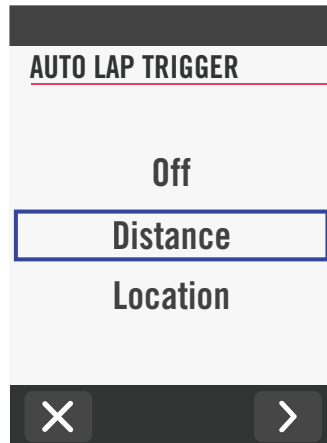
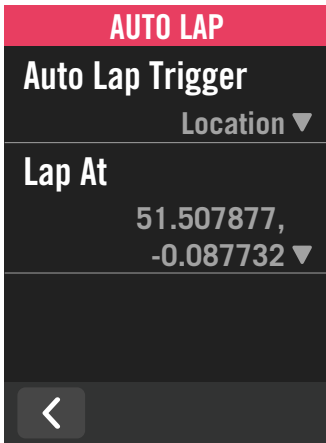

Auto Lap:

- Auto Lap Trigger: You can use the Auto Lap to mark the lap at a particular position automatically. Choose by Distance or Location option to trigger laps counts.
- Set desired settings or type value by pressing > icon.
- If you select Distance, you need to enter a specific value. If you choose Location, you need to wait for the device to acquire satellite signal to locate your current position.

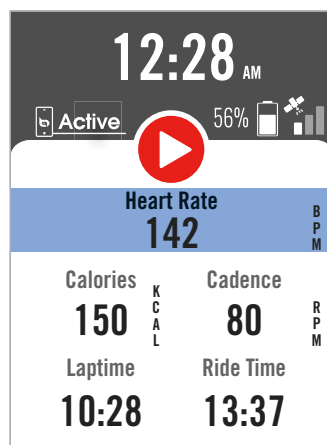
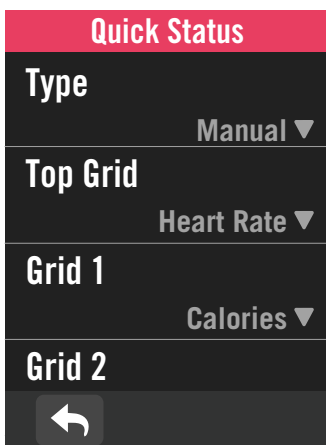

Quick Status:

- You can customize the quick status by selecting different data for each grid.
- Color of the top grid will change by different zones, which are based on the settings. ([See P.7 for more information](#))

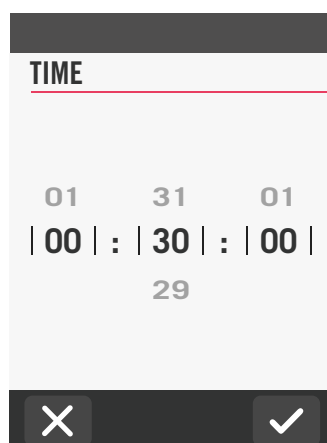
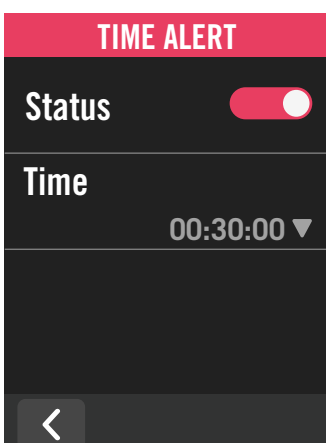

Alert:

- Enable status.
- Adjust desired settings for Time, Distance, Speed, Heart Rate, or Cadence.



GPS System

Rider S500 has full GNSS (Global Navigation Satellite System) support including GPS, GLONASS (Russia), BDS (China), QZSS (Japan) and Galileo (EU). You can select a suitable GPS Mode according to your location to enhance accuracy or better suit your needs.

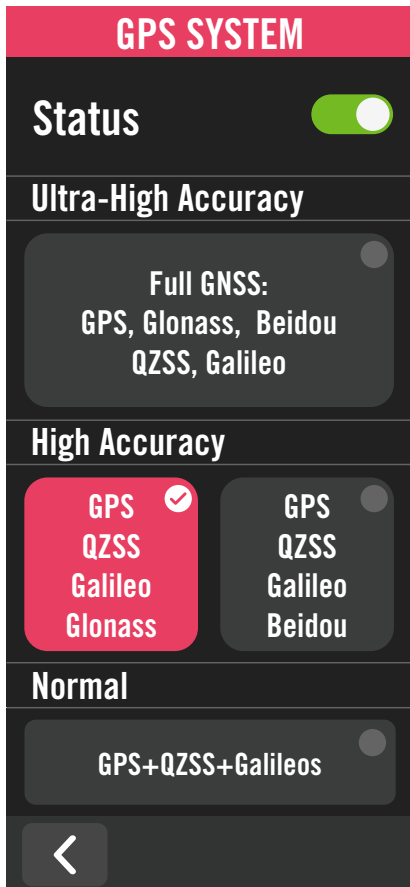

1. Select  in the home page.
2. Select **Bike Settings**.
3. Select a bike > **GPS System**.

Enable GPS System

1. Turn on GPS System status.
2. Select a suitable satellite navigation system.
 - GPS+QZSS+Galileo+Glonass : Choose this combination if you're in NON Asia-Pacific region for the best accuracy.
 - GPS+QZSS+Galileo+Beidou :
This combination will provide the best accuracy in Asia-Pacific region.
 - GPS+Galileo+QZSS Navigation Satellite System: It's sufficient for regular usages, while consuming less battery power than the 2 sets above.
 - Power Saving : Trade-off accuracy to achieve maximum battery life. Use this mode in open sky.

Disable GPS System

1. Turn off GPS to save battery power when GPS signal is not available, or when GPS information is not mandatory (such as indoor training).

Speed Priority

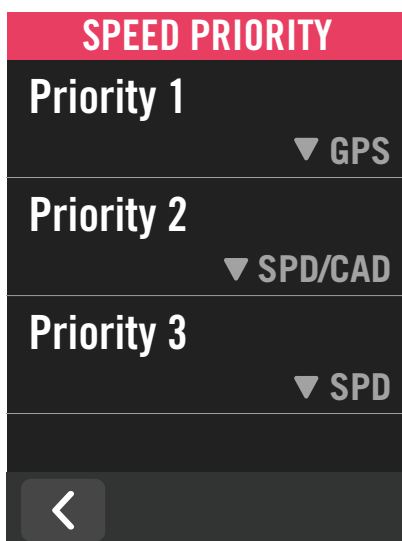

1. Select  in the home page.
2. Find **Bike Settings**.
3. Choose a bike > **Speed Priority**.
4. Switch speed source to order priorities.

NOTE: If the GPS signal is not fixed, a “Please go outdoors to an open area to acquire GPS satellite signal.” message will appear on the screen. Check if GPS is on and make sure you step outside to acquire signal.



Overview

Select Overview to view more details of the bike odometer.

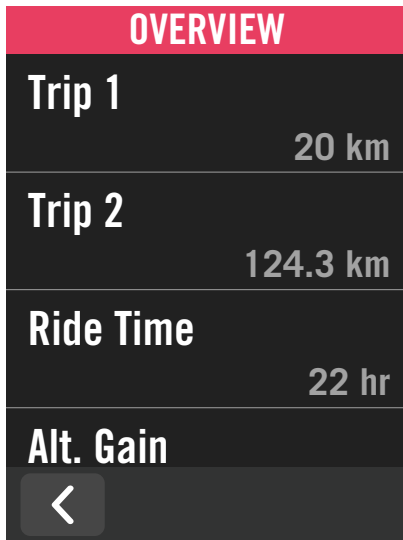

1. Find  in the home page.
2. Tap **Bike Settings**.
3. Select a bike profile > **Overview**.

Trip 1 / 2:

Cumulative mileage recorded before you reset it. You are free to use Trip 1 or Trip 2 to record travel distance in a period and reset it.

Trip 1 and 2 will show in the same value before you reset one or each of them.

For instance, if you plan to change your tires after riding 100 km, you can reset Trip 1 or Trip 2 to 0 when you install new tires. After a few rides, you can view the total trip distance since you changed the tires to see how many distance remains to change tires.

Display

You can change the display setting such as Brightness, Backlight, and Meter Page Mode.

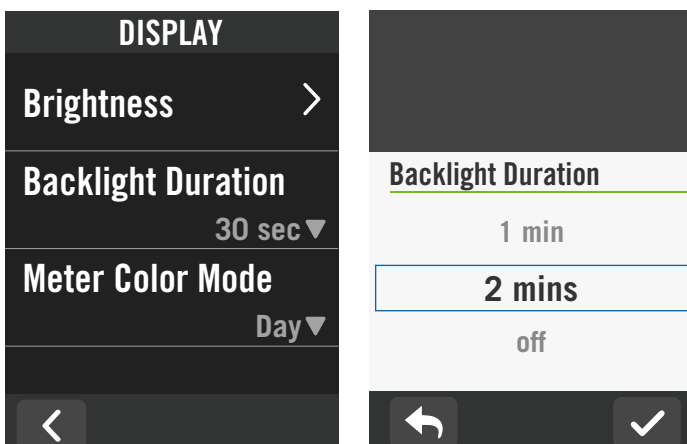

1. Select  in the home page.
2. Select **Display > Brightness**.

Backlight Duration

1. Swipe up and down for selecting preferred duration.

Meter Color Mode

1. You can choose Day or Night mode for different color of the meter pages.

Pair Sensors

We suggest that you pair all your sensors with the device beforehand, Rider S500 will scan for nearby active sensors from the sensor pool, making switching between bikes and sensors easier and more convenient than ever.

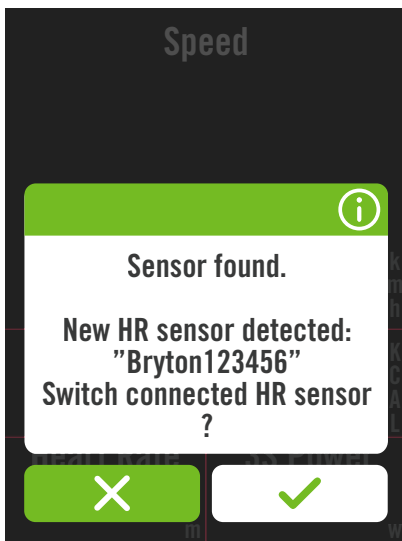
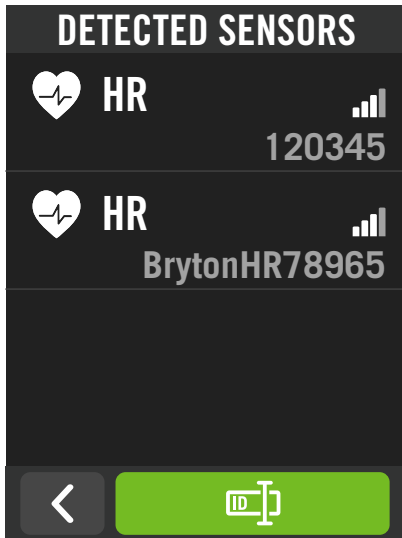

1. Select  in the home page.

2. Find **Sensors**.

Add New Sensors

1. Select  to add new sensors.

2. Choose any type of sensor that you would like to pair with.

3. To pair sensors with your device, please have Bryton Smart Sensors installed first, then wear a heart rate monitor or rotate the crank and wheel a few times to wake Bryton Smart Sensors up.

4. For Bike Radars, E-bikes, and Ess/Di2, please turn the power on before starting pairing.

5. Let the device detect sensors automatically or select  to enter a sensor ID manually.

6. Pick a detected sensor you would like to pair with then select  to save.

Disconnect sensors

1. Select the sensor you would like to deactivate.

2. Turn off the status to disband the sensor.

Activate Paired Sensors

1. Select the sensor you would like to activate.
2. Turn on sensor status then sensors will be connected automatically.

3. If the sensor failed to be connected or you want to switch to this sensor, select  to reconnect it with your device.

Remove sensors

1. Choose the sensor you would like to remove.

2. Tap Remove and click  to confirm.

Switch Sensors

1. If another paired sensor is detected, the device will ask you if you want to switch to another sensor.

2. Tap  to switch the sensor.

NOTE:

- If you select X in the sensor found notification, the detected sensor would be deactivated. You will need to turn on its Status to activate it again.
- Sensors only need to be switched if they are in the same type and both are already added in the list.



Using Electronic Shifting Systems

After pairing electronic shifters, such as Shimano Di2 or SRAM, you can enter the sensor pages for further settings. To customize the data grids on meter pages, please go to [page 5](#) for more instruction.

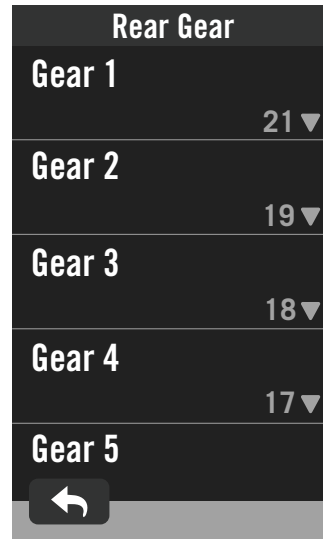
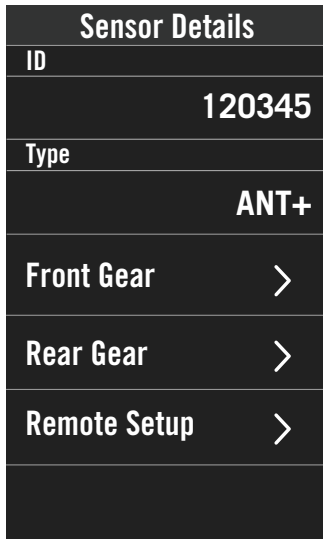

1. Select  in the home page.
2. Find **Sensors**.
3. Select the electronic shifter you paired.
4. Enter Sensor Details to input the tooth numbers.

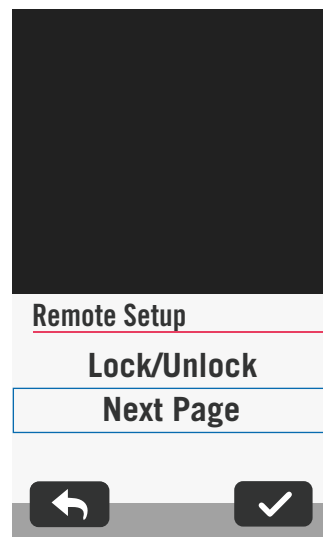
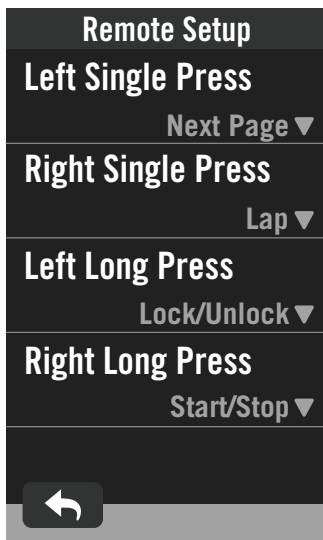

Remote Setup

1. Enter Remote Setup
2. Click on  in each option to set up different functions for each button.

Manage Sensors via Bryton Active



1. Select Settings in the home page.
2. Find **Sensors**.

Add New Sensors

1. Select **Add Sensor** to add new sensors.
2. Choose any type of sensor that you would like to pair with.
3. To pair sensors with your device, please have Bryton Smart Sensors installed first, then wear a heart rate monitor or rotate the crank and wheel a few times to wake Bryton Smart Sensors up.
4. For Bike Radars, E-bikes, and Ess/Di2, please turn the power on before starting pairing.
5. Let the device detect sensors automatically or enter a sensor ID manually.
6. Pick a detected sensor you would like to pair with then select **OK** to save.

Manage Sensors

1. Select the sensor you would like to edit.
2. Turn on or off the status to activate or deactivate the sensor.
3. Edit the name by clicking .
4. Remove the sensor by pressing **Remove**.

Switch Sensors

1. Select the sensor you would like to switch to.
2. Press **Connect** to pair the sensor.

NOTE: Sensors only need to be switched if they are in the same type and both are already added in the list.







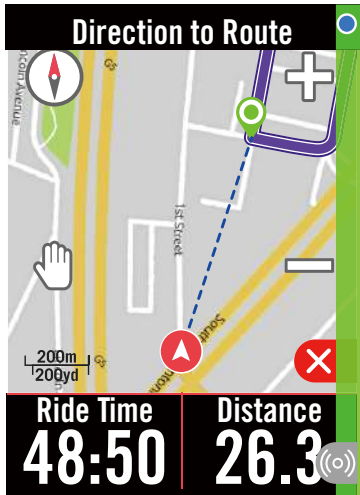

Bike Radar

The Rider S500 supports ANT+ Radar after simple pairing. While in the Meter Page, the radar strip will display approaching vehicles, utilizing the Rider S500's vivid color screen for easy-to-understand vehicle icons and color changes for status.

Additionally, audio alerts can be configured with the radar to notify you if an oncoming vehicle passes the distance threshold.



	Bike radar is connected.
	Rider's position
	Approaching vehicle
	Safe: No vehicle is detected around.
	Caution: A vehicle is approaching.
	High Awareness: A vehicle is approaching at high speed.

NOTE:

- If there is no vehicle around you in 150m, the color strip will not show on the screen.
- Please go to [Page 29](#) to see how to pair a bike radar with Rider S500.

Using E-bike

The Rider S500 incorporates Shimano Steps and ANT+ LEV e-bike support for compatible brands to display various e-bike data, including assist mode, assist level shifting mode, E-Bike battery, travel range and rear gear position.

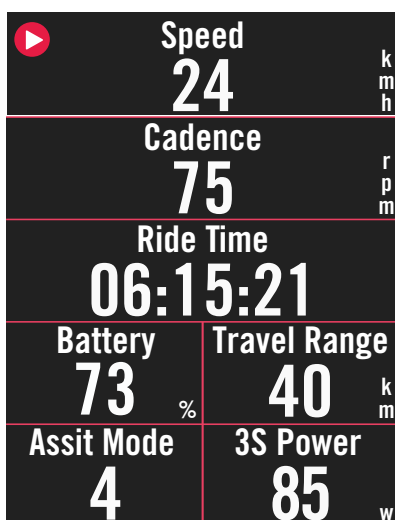

1. Before you can use a compatible e-bike, you must pair it with the Rider S500.
2. You can customize the compatible e-bike data fields.

NOTE:

- Only supported on compatible e-bike systems. Some of the data from incompatible e-bikes will be unable to display on the Rider S500.

System

In System, you can customize System Settings, Recording Settings, Auto Scroll, Start Remind, File Saving, Memory, ODO, and Data Reset.

System Settings

You can setup Language, Backlight Duration, Meter Color Mode, Key Tone, Sound, Time/Unit, Auto Lock, and Status Duration.

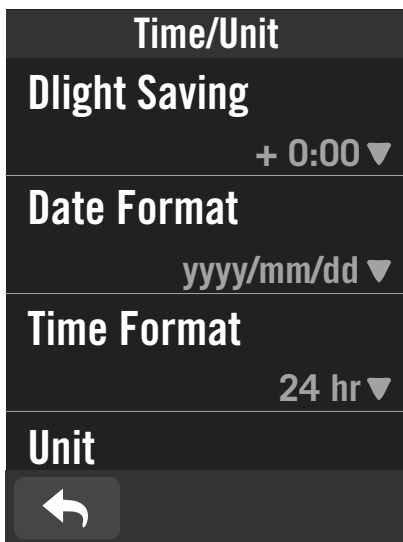
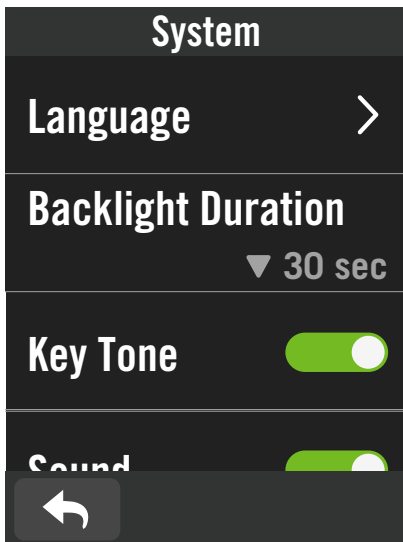

1. Tap  in the home page.
2. Select **System > System Settings**.

Language

1. Select your desired language.

Backlight Duration

1. Select desired setting.
2. Select  to confirm.

Keytone

1. Enable or disable **Key Tone** to change the settings for key presses.

Sound

1. Turn on or off **Sound** to change the settings for alerts and notifications.

Time / Unit

1. Select **Dlight Saving, Date Format, Time Format, Unit, and Temperature** to change the settings.

Recording Settings

In Recording Settings, data recording frequency can be customized for higher accuracy / data saving, as well as how data is included depending on user preference.

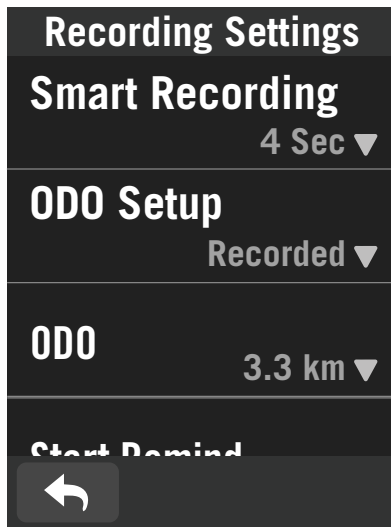

1. Select  in the home page.
2. Select **System > Recording Settings**.

Smart Recording



1. Set your desired smart recording time.
2. Select  to confirm.

ODO Setup

1. Select **Recorded** or **All** and select  to confirm.

Start Remind

When the device detects the motion of your bike, a reminder will pop up and ask you if you would like to start recording. You can set the frequency of the reminder

1. Select  in the home page.
2. Find **System > Recording Settings > Start Remind**.
3. Select  to confirm.

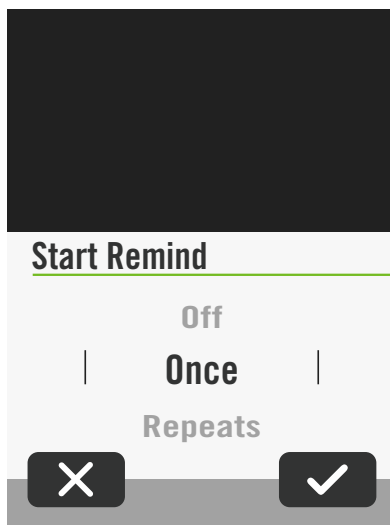

NOTE:

- **All** means the odometer would show the cumulative distance of all trips; **Recorded** would only show the cumulative distance of recorded trip.



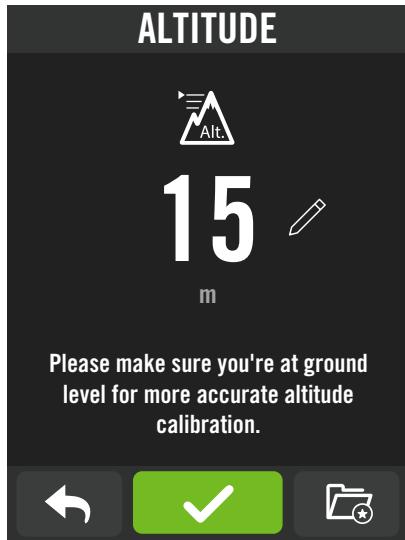

Altitude

With connection to Internet, Rider S500 provides altitude information for you to calibrate directly. You can also change altitude manually.



Calibrate Altitude

1. Choose  in the home page.
2. Select **Altitude**.
3. Click on the number to change the value.
4. Select  to confirm.
5. You can also save particular locations for auto calibrating. Find  and set the positions.

NOTE:

The value of altitude on the meter mode will be changed once current altitude is adjusted.

About

You can view your device current firmware version.

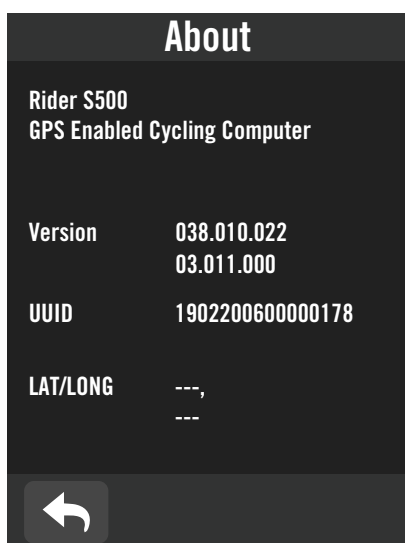

1. Select  in the home page.
2. Select **About**.
3. Firmware information and current latitude and longitude will show on the device.

Profile

In Profile, you can browse and personalize your information.

Personal Information

PROFILE

Device Name
Katherine

Gender
Female ▼

Birthday
1997/07/07 ▼

Height

←

Heart Rate Zone

MHR LTHR

Based on LTHR
172 bpm ▼

Zone 1
111-139 bpm 65% ▼

Zone 2 81% ▼

←

1. Select  in the home page.
2. Select **Heart Rate Zone** and tap to edit details.

Customize Heart Rate Zone

1. Select **MHR**.
 - Use keyboard to enter MHR.
 - Press ▼ to edit details for each zone.
 - Select ✓ to confirm.
 - Scroll up and down to edit more zones.
2. Select **LTHR**.
 - Use keyboard to enter LTHR.
 - Press ▼ to edit details for each zone.
 - Select ✓ to confirm.
 - Scroll up and down to edit more zones.

Customize Power Zone

1. Select **MAP**.
 - Use keyboard to enter MAP.
 - Press ▼ to edit details for each zone.
 - Select ✓ to confirm.
 - Scroll up and down to edit more zones.
2. Select **FTP**.
 - Use keyboard to enter FTP.
 - Press ▼ to edit details for each zone.
 - Select ✓ to confirm.
 - Scroll up and down to edit more zones.

NOTE: Heart Rate Graphical Data will be displayed based on the selection of LTHR or MHR. Power Graphical Data will be displayed based on the selection of FTP or MAP. Please go to [page 6](#) to see more detail of Graphic mode.

Bryton App Advanced Settings

After pairing your Rider S500 with Bryton Active App, you will have access to Notifications.

Notifications

After pairing your compatible smartphone using Bluetooth Smart wireless technology with Rider S500, you can receive phone calls, texts and email notifications on your Rider S500.

1. iOS Phone Pairing

- a. Go to your phone “Settings>Bluetooth” and enable Bluetooth.
- b. Go to Bryton Mobile App and Tap on “Settings>Device Manager>+”.
- c. Select and add your device by pressing “+”.
- d. Tap on “Pair” to pair your device with your phone. (For iOS phone only)
- e. Tap on “Finish” to complete pairing.

NOTE: If notifications do not work properly, in your phone, please go to “Settings>Notifications” and check if you have allowed notifications in compatible messaging and email apps or go to social applications settings.

1. Android Phone Pairing

- a. Go to your phone “Settings>Bluetooth” and enable Bluetooth.
- b. Go to Bryton Mobile App and Tap on “Settings>Device Manager>+”.
- c. Select and add your device by pressing “+”.
- d. Tap on “Finish” to complete pairing.

2. Allow Notification Access

- a. Tap on “Settings> Notification”.
- b. Tap on “OK” to enter setting to allow Notification Access for Bryton app.
- c. Tap on “Active” and select “OK” to allow notification access for Bryton.
- d. Go back to Notification settings.
- e. Select and enable In-coming Calls, Text Messages and Emails by Tap onping each item.

Appendix

Specification

Rider S500

Item	Description
Display	2.4" color TFT 240x320 capacitive touch screen
Physical Size	83.9 x 51 x 17.4 mm
Weight	87 g
Operating Temperature	-10°C ~ 50°C
Battery Charging Temperature	0°C ~ 40°C
Battery	Li-polymer rechargeable battery
Battery Life	Up to 30 hours with open sky
ANT+™	Featuring certified wireless ANT+™ connectivity. Visit www.thisisant.com/directory for compatible products. 
GNSS	Integrated high-sensitivity GNSS receiver with embedded antenna
BLE Smart	Bluetooth smart wireless technology with embedded antenna; 2.4GHz band 0dBm
Water Resistant	Water resistant to a depth of 1 meter for up to 30 minutes
Barometer	Equipped with barometer
Wireless Local Area Network	IEEE 802.11 b/g/n; 2.4GHz band 8dBm

Smart Speed Sensor (Optional)

Item	Description
Physical Size	36.9 x 34.8 x 8.1 mm
Weight	6 g
Water Resistance	Incidental exposure to water of up to 1meter for up to 30mins
Transmission Range	3 m
Battery Life	Up to 1 year
Operating Temperature	-10°C ~ 60°C
Radio Frequency/protocol	2.4GHz / Bluetooth 4.0 and Dynastream ANT+ Sport wireless communications protocol

NOTE: Accuracy may be degraded by poor sensor contact, electrical, magnetic interference and distance from the transmitter. To avoid magnetic interference, it is recommended that you change location, clean or replace chain.



Smart Cadence Sensor (Optional)

Item	Description
Physical Size	36.9 x 31.6 x 8.1 mm
Weight	6 g
Water Resistance	Incidental exposure to water of up to 1 meter for up to 30 minutes
Transmission Range	3 m
Battery Life	Up to 1 year
Operating Temperature	-10°C ~ 60°C
Radio Frequency/protocol	2.4GHz / Bluetooth 4.0 and Dynastream ANT+ Sport wireless communications protocol

NOTE:

Accuracy may be degraded by poor sensor contact, electrical, magnetic interference and distance from the transmitter.

Smart Heart Rate Monitor (Optional)

Item	Description
Physical Size	63 x 34.3 x 15 mm
Weight	14,5 g (sensor) / 31,5 g (correa)
Water Resistance	Incidental exposure to water of up to 1 meter for up to 30 minutes
Transmission Range	3 m
Battery Life	Up to 2 years
Operating Temperature	0°C ~ 50°C
Radio Frequency/protocol	2.4GHz / Bluetooth 4.0 and Dynastream ANT+ Sport wireless communications protocol

Battery Information

Smart Speed Sensor and Smart Cadence Sensor

Both sensors contain a user-replaceable CR2032 battery.

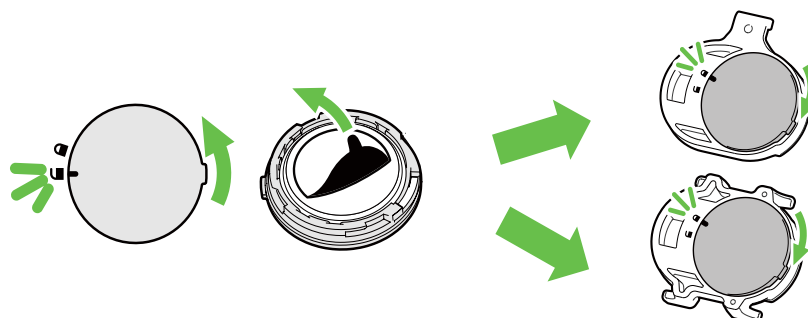

Before using sensors:

1. Locate the circular battery cover on the back of sensors.
2. Use your finger to press and twist cover counter-clockwise so the indicator on the cover points to unlock icon (🔓).
3. Remove the cover and battery tab.
4. Use your finger to press and twist cover clockwise so the indicator on the cover points to locked icon (🔒).

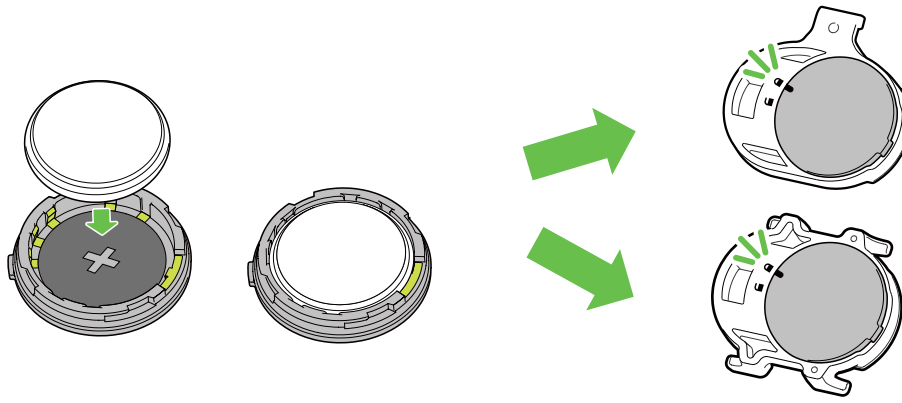



To replace the battery:

1. Locate the circular battery cover on the back of sensors.
2. Use your finger to press and twist cover counter-clockwise so the indicator on the cover points to unlock icon ().
3. Remove the battery and insert new battery with positive connector first into the battery chamber.
4. Use your finger to press and twist cover clockwise so the indicator on the cover points to locked icon ().

NOTE:

- When installing a new battery, if the battery is not placed with the positive connector first, the positive connector will easily deform and malfunction.
- Be careful not to damage or lose O-ring gasket on the cover.
- Contact your local waste disposal department to properly dispose of used batteries.

Smart Heart Rate Monitor

The heart rate monitor contains a user-replaceable CR2032 battery.

To replace the battery:

1. Locate the circular battery cover on the back of the heart rate monitor.
2. Use a coin to twist the cover counter-clockwise.
3. Remove the cover and battery.
4. Insert the new battery, with the positive connector facing upward and lightly press it.
5. Use a coin to twist the cover clockwise.

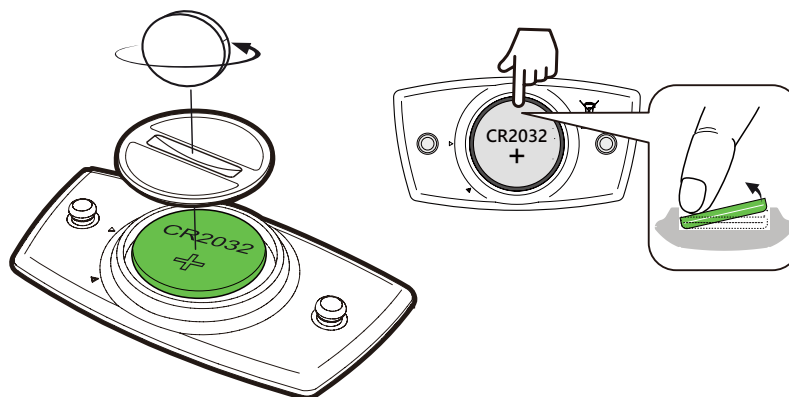

NOTE:

- Be careful not to damage or lose the O-ring gasket.
- Contact your local waste disposal department to properly dispose of of used batteries.



Install Rider S500

Use Sport Mount to Mount Rider S500

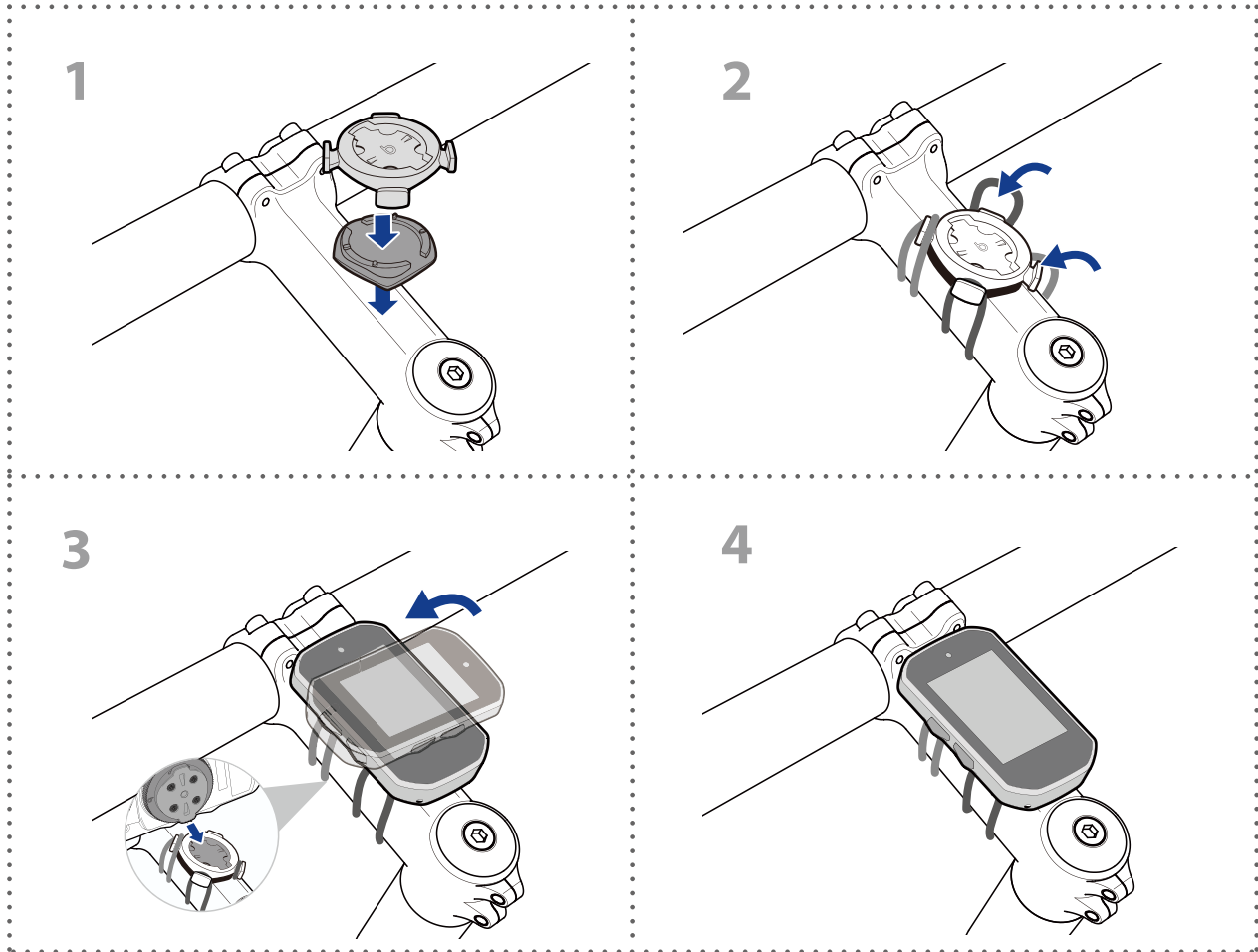

Use F-Mount to Mount Rider S500

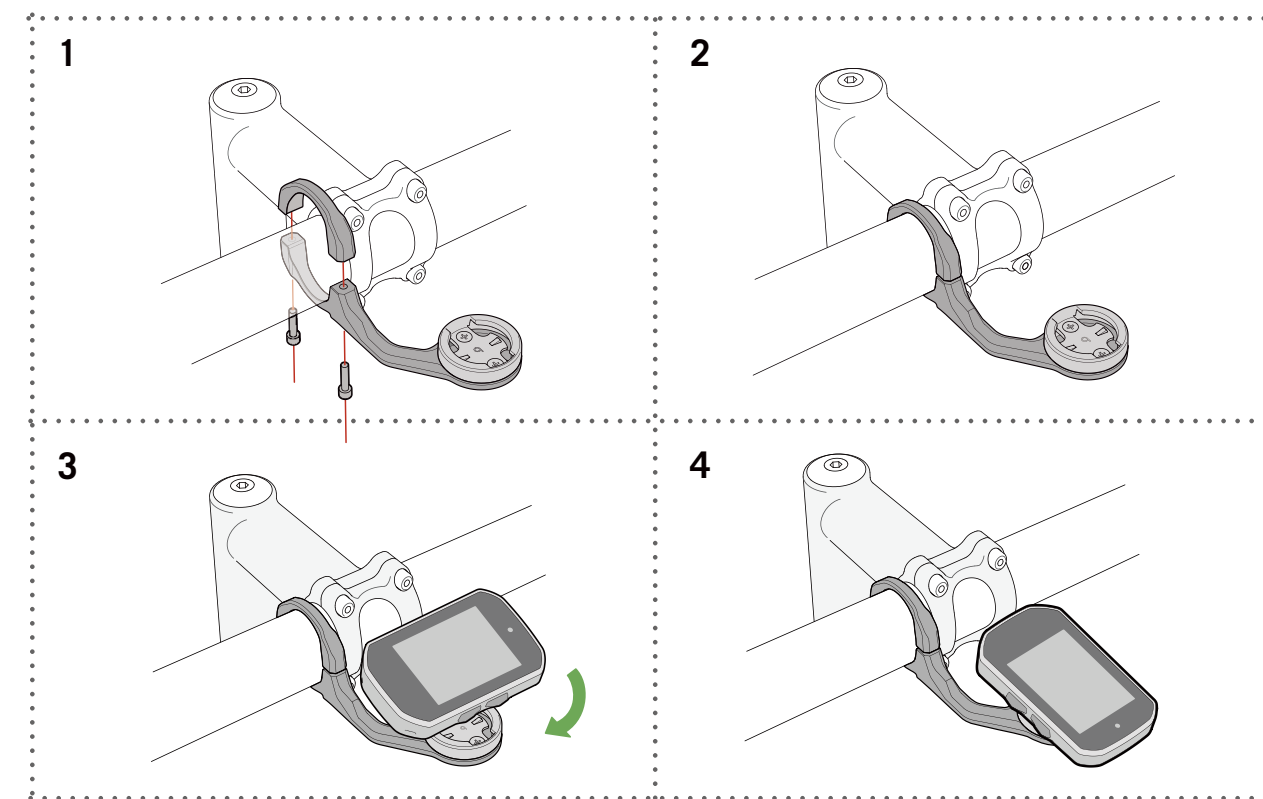

Install the Speed/Cadence Sensor (Optional)

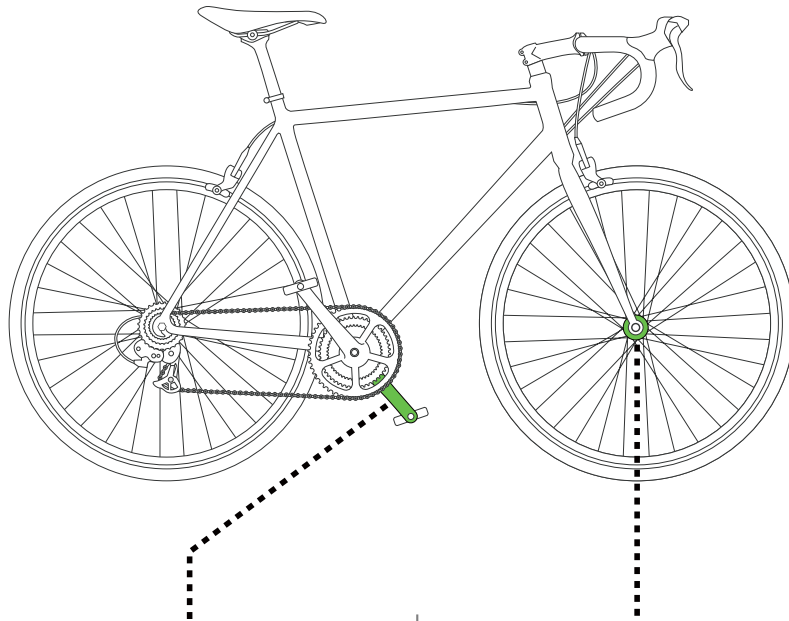

Smart Cadence Sensor

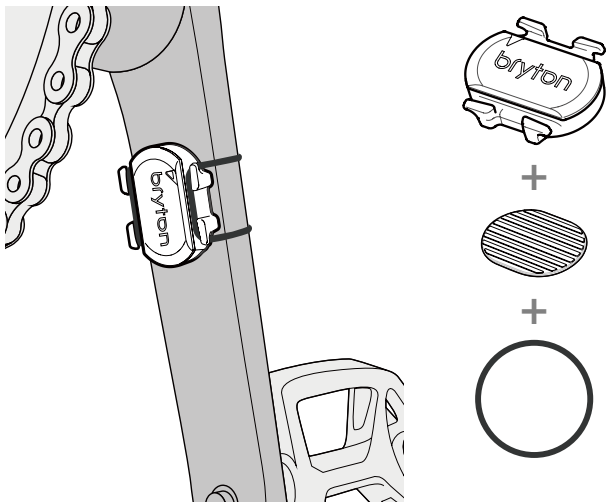

Smart Speed Sensor

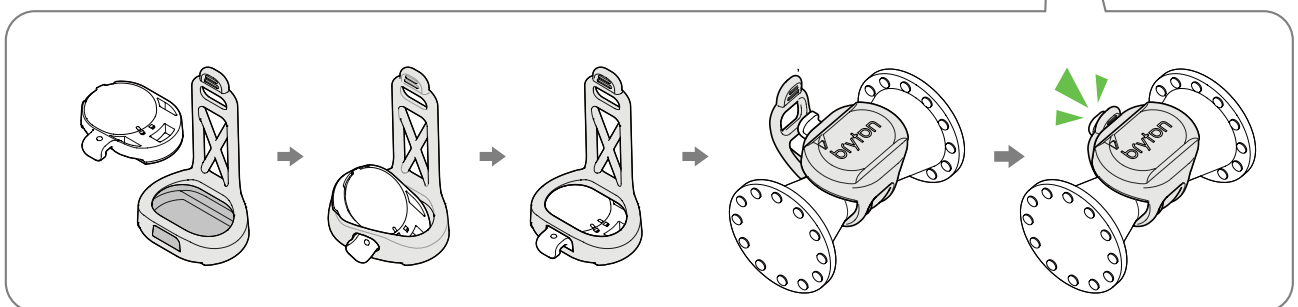
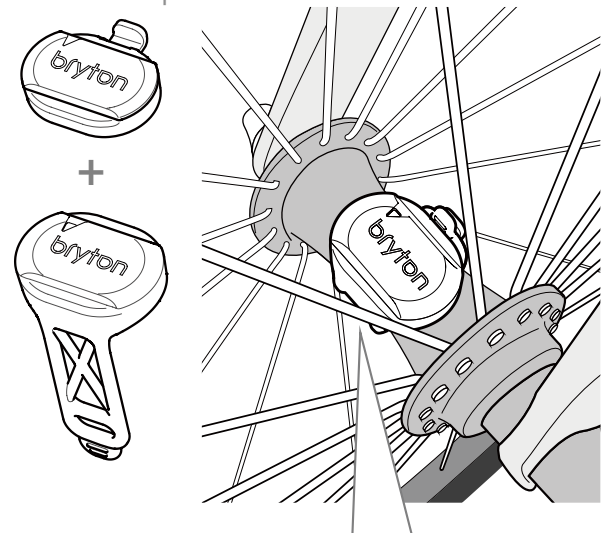

NOTE:

- Once sensors are waken, the LED blinks twice. The LED continues to blink when you continue to pedal for pairing. After around 15 times blink, it stops blinking. If not used for 10 minutes, sensor would go into sleep mode to preserve power. Please complete the pairing during the time the sensor is awake.



Install Heart Rate Belt (Optional)

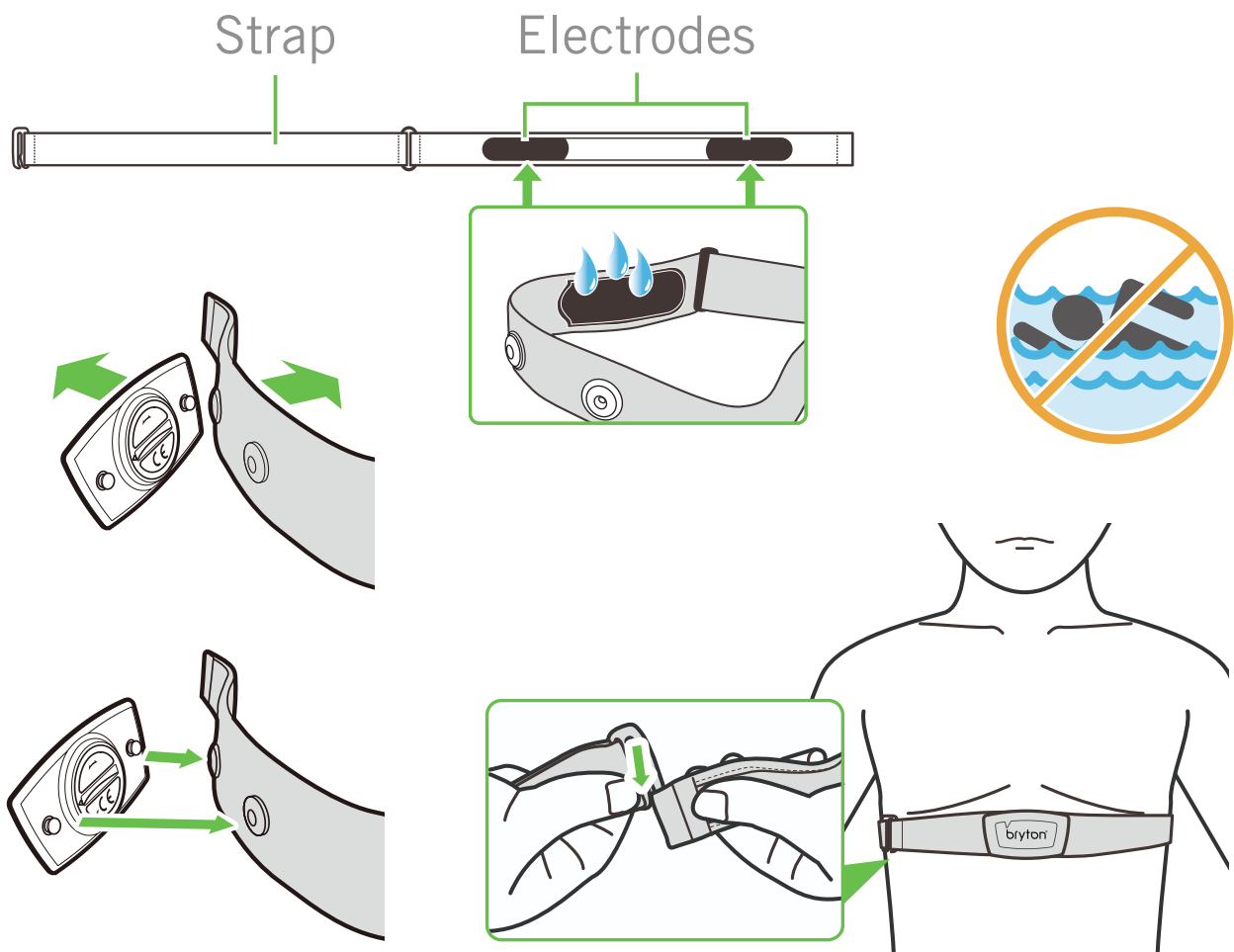

NOTE:

- In cold weather, wear appropriate clothing to keep the heart rate belt warm.
- The belt should be worn directly on your body.
- Adjust the sensor position to the middle part of the body (wear it slightly below the chest). The Bryton logo shown on the sensor should be facing upward. Tighten the elastic belt firmly so that it will turn loose during the exercise.
- If the sensor cannot be detected or the reading is abnormal, please warm up for about 5 minutes.
- If the heart rate belt is not used for a period of time, remove the sensor from the heart rate belt.

NOTE: Improper battery replacement may cause an explosion. When replacing a new battery, use only the original battery or a similar type of battery specified by the manufacturer. Disposal of the used batteries must be carried out in accordance to the regulations of your local authority.



For better environmental protection, waste batteries should be collected separately for recycling or special disposal.



Wheel Size and Circumference

The wheel size is marked on both sides of the tires.

Wheel Size	L (mm)
12x1,75	935
12x1,95	940
14x1,50	1020
14x1,75	1055
16x1,50	1185
16x1,75	1195
16x2,00	1245
16 x 1-1/8	1290
16 x 1-3/8	1300
17x1-1/4	1340
18x1,50	1340
18x1,75	1350
20x1,25	1450
20x1,35	1460
20x1,50	1490
20x1,75	1515
20x1,95	1565
20x1-1/8	1545
20x1-3/8	1615
22x1-3/8	1770
22x1-1/2	1785
24x1,75	1890
24x2,00	1925
24x2,125	1965
24 x 1 (520)	1753
Tubular 24 x 3/4	1785
24x1-1/8	1795
24x1-1/4	1905
26 x 1 (559)	1913
26x1,25	1950
26x1,40	2005
26x1,50	2010
26x1,75	2023
26x1,95	2050
26x2,10	2068
26x2,125	2070
26x2,35	2083

Wheel Size	L (mm)
26x3,00	2170
26x1-1/8	1970
26x1-3/8	2068
26x1-1/2	2100
650C Tubular 26 x 7/8	1920
650x20C	1938
650x23C	1944
650 x 25C 26 x 1 (571)	1952
650x38A	2125
650x38B	2105
27 x 1 (630)	2145
27x1-1/8	2155
27x1-1/4	2161
27x1-3/8	2169
27,5x1,50	2079
27,5x2,1	2148
27,5x2,25	2182
700x18C	2070
700x19C	2080
700x20C	2086
700x23C	2096
700x25C	2105
700x28C	2136
700x30C	2146
700x32C	2155
700C Tubular	2130
700x35C	2168
700x38C	2180
700x40C	2200
700x42C	2224
700x44C	2235
700x45C	2242
700x47C	2268
29x2,1	2288
29x2,2	2298
29x2,3	2326



Data Field

Category	Data Field	Description of Data Fields
Altitude	Altitude	The height of your current location above or below sea level.
	Max Altitude	The highest height of your current location above or below sea level which the rider achieved for the current activity.
	Alt. Gain	The total altitude distance gained during this current activity.
	Alt. Loss	The total altitude lost during this current activity.
	Grade	The calculation of altitude over distance.
	Uphill Dist.	The total distance traveled while ascending.
	Downhill Dist.	The total distance traveled while descending.
	Alt. Gain(lap)	The total altitude distance gained during the current lap.
	Alt. Loss(lap)	The total altitude lost during the current lap.
	Avg Grade(lap)	The average gradient for the current lap.
	VAM	Average ascent speed
Distance	Distance	The distance traveled for current activity.
	ODO	The accumulated total distance until you reset it.
	LapDistance	The distance traveled for the current lap.
	LLapDist.	The distance traveled for the last finished lap.
	Trip 1/Trip 2	Cumulative mileage recorded before you reset it. They are 2 separate trip measurements. You are free to use Trip 1 or Trip 2 to record, for example, weekly total distance and use another to record, for example, monthly total distance.
Speed	Speed	The current rate of change in distance.
	Avg Speed	The average speed for current activity.
	Max Speed	The maximum speed for current activity.
	LapAvgSpd	The average speed for the current lap.
	LapMaxSpd	The maximum speed for the current lap.
	LLapAvgSpd	The average speed for the last finished lap.
Cadence	Cadence	The current rate at which rider is pedalling the pedals.
	Avg CAD	The average cadence for current activity.
	Max CAD	The maximum cadence for current activity.
	LapAvgCad	The average cadence for the current lap.
	LLapAvCad	The average cadence for the last finished lap.



Category	Data Field	Description of Data Fields
Energy	Calories	The number of total calories burned.
	Kilojoules	The accumulated power output in kilojoules for the current activity.
Time	Time	Current GPS Time.
	Ride Time	The time spent on riding for current activity.
	Trip Time	Total time spent for current activity.
	Sunrise	The time of sunrise based on your GPS location.
	Sunset	The time of sunset based on your GPS location.
	LapTime	The stopwatch time for the current lap.
	LLapTime	The stopwatch time for the last finished lap.
	Lap Count	The number of laps finished for the current activity.
Heart Rate	Heart Rate	The number of times your heart beats per minute. It requires compatible HR sensor pairing connection to your device.
	Avg HR	The average heart rate for current activity.
	Max HR	The maximum heart rate for current activity.
	MHR %	Your current heart rate divided by Maximum Heart Rate. MHR means that the maximum number of beats made by your heart in 1 minute of effort. (MHR is different from Max HR. You will need to set MHR in User Profile)
	LTHR%	Your current heart rate divided by Lactate Threshold Heart Rate. LTHR means that the average heart rate while in the intense exercise at which the blood concentration of lactate begins to exponentially increase. (You will need to set LTHR in User Profile)
	HR Zone	The current range of your Heart Rate (Zone 1 to Zone 7).
	MHR Zone	The current range of your Maximum Heart Rate Percentage heart rate (Zone 1 to Zone 75).
	LTHR Zone	The current range of your Lactate Threshold Heart Rate Percentage (Zone 1 to Zone 7).
	LapAvgHR	The average heart rate for the current lap.
	LLapAvgHR	The average heart rate for the last finished lap.
	Lap MHR%	The average of MHR% for the current lap.
Lap LTHR%	The average of LTHR% for the current lap.	
Time in zone	The time you reach the value of the different zones.	

Category	Data Field	Description of Data Fields
Power	Power Now	Current Power in Watt.
	Avg Power	The average power for the current activity.
	Max Power	The maximum power for the current activity.
	LapAvgPw	The average power for the current lap.
	LapMaxPw	The maximum power for the current lap.
	3s power	3 seconds average of power
	10s power	10 seconds average of power
	30s power	30 seconds average of power
	NP (Normalized Power)	An estimate of the power that you could have maintained for the same physiological “cost” if your power had been perfectly constant, such as on an ergometer, instead of variable power output.
	w/kg	Power to weight ratio
	TSS (Training Stress Score)	Training Stress Score is calculated by taking into account both the intensity such as IF and the duration of the ride. A way of measuring how much stress is put on the body from a ride.
	IF (Intensity Factor)	Intensity Factor is the ratio of the normalized power(NP) to your Functional Threshold Power(FTP). An indication of how hard or difficult a ride was in relation to your overall fitness.
	SP (Specific Power)	Power-to-weight ratio
	FTP Zone	The current range of your Functional Threshold Power Percentage (Zone1 to Zone 7).
	MAP Zone	The current range of your Maximum Aerobic Power Percentage (Zone 1 to Zone 7).
	MAP%	The current power divided by your Maximum Aerobic Power.
	FTP%	The current power divided by your functional threshold power.
	Lap NP	Normalized power of the current lap
LLapAvgPw	The average power output for the last finished lap.	
LlapMaxPw	The maximum power for the last finished lap.	
Left Power	The Left-side power meter value.	
Right Power	The Right-side power meter value.	
Heading	Heading	Heading function informs you which direction you are currently heading.
Temperature	Temp	The current temperature.



Category	Data Field	Description of Data Fields
Pedal Analysis	CurPB-LR	The current left/right power balance.
	AvgPB-LR	The average left/right power balance for the current activity.
	CurTE-LR	The current left/right percentage of how efficiently a rider is pedaling.
	MaxTE-LR	The maximum left/right percentage of how efficiently a rider is pedaling.
	AvgTE-LR	The average left/right percentage of how efficiently a rider is pedaling.
	CurPS-LR	The current left/right percentage of how evenly a rider is applying force to the pedals throughout each pedal stroke.
	MaxPS-LR	The maximum left/right percentage of how evenly a rider is applying force to the pedals throughout each pedal stroke.
	AvgPS-LR	The average left/right percentage of how evenly a rider is applying force to the pedals throughout each pedal stroke.
Workout	Target power	You can set a power target for your workout plan.
	Target cadence	You can set a cadence target for your workout plan.
	Target heartrate	You can set a target of heart rate zone for your workout plan.
	Remaining step time	The remaining distance of the current training.
	Remaining workout time	The remaining duration of the current training.
	Interval count	The number of the intervals of your workout.
Route	Dist to POI	Distance to next point of interest.
	Dist to Peak	Distance to next peak.
	Turn Info	Inform the rider the information of every turn.
	Dist to Destination	The remaining distance to the destination.

Category	Data Field	Description of Data Fields
Graph	SPD Ring	The current speed rate displays in dynamic coloured graphical mode.
	SPD Bar	
	CAD Ring	The current cadence rate displays in dynamic coloured graphical mode.
	CAD Bar	
	HR Ring	The current heart rate displays in dynamic coloured graphical mode.
	HR Bar	
	PW Ring	The current power rate displays in dynamic coloured graphical mode.
	PW Bar	
	3s PW Ring	3 seconds average of power displays in dynamic coloured graphical mode.
	10s PW Ring	10 seconds average of power displays in dynamic coloured graphical mode.
	30s PW Ring	30 seconds average of power displays in dynamic coloured graphical mode.
Ebike	Ebike Battery	The battery status of the conneted ebike.
	Travel Range	The possible distance that a rider could ride with the ebike.
	Assist Mode	Various modes provided by the ebike with assigned levels of assistance.
	Assist Level	The level of electronic assistance provided by the ebike in a given power mode.
	Ebike Rear Gear	The gear position of the rear derailleur of Ebike displayed by the graphic.
	Assist Mode & Level	The current ebike assist mode and level of electronic assistance.
Electronic Gear-Shifting Systems	ESS/Di2 Battery Level	The remaining battery power of the ESS/Di2 system.
	Front Gear	The gear position of the front derailleur displayed by the graphic.
	Rear Gear	The gear position of the rear derailleur displayed by the graphic.
	Gear Ratio	The ratio of the current teeth of the front gear to that of the rear gear.
	Gears	The front and rear bike gears position displayed by numbers.
	Gear Combo	The current gear combination of the front gear and the rear gear.

NOTE: Only supported for e-bike systems that support listed data.



Basic Care For Your Rider S500

Taking good care of your device will reduce the risk of damage to your device.

- Do not drop your device or subject it to severe shock.
- Do not expose your device to extreme temperatures and excessive moisture.
- The screen surface can easily be scratched. Use the non-adhesive generic screen protectors to help protect the screen from minor scratches.
- Use diluted neutral detergent on a soft cloth to clean your device.
- Do not attempt to disassemble, repair, or make any modification to your device. Any attempt to do so will make the warranty invalid.



RF Exposure Information (MPE)

This device meets the EU requirements and the International Commission on Non-Ionizing Radiation Protection (ICNIRP) on the limitation of exposure of the general public to electromagnetic fields by way of health protection. To comply with the RF exposure requirements, this equipment must be operated in a minimum of 20 cm separation distance to the user.

Hereby, Bryton Inc. declares that the radio equipment type Bryton product is in compliance with Directive 2014/53/EU. The full text of the EU declaration of conformity is available at the following internet address:

http://www.brytonsport.com/download/Docs/CeDocs_RiderS500.pdf



Designed by Bryton Inc.

Copyright© 2021 Bryton Inc. All rights reserved.

7F, No.75, Zhouzi St., Neihu Dist., Taipei City 114, Taiwan (R.O.C.)

