

POLAR®

POLAR UNITE



USER MANUAL

CONTENTS

Contents	2
Polar Unite User Manual	6
Introduction	6
Take full advantage of your Polar Unite	7
Polar Flow web service	7
Get started	8
Setting up your watch	8
Option A: Set up with a phone and Polar Flow app	10
Option B: Set up with your computer	10
Option C: Set up from the watch	10
Using Polar Unite in stand-alone mode	10
Features that are not available in stand-alone mode	10
Polar Flow provides a detailed analysis of your training, activity and sleep data	11
How to wear the Polar Unite wristband	11
Button functions and touch display	13
Color touch display	13
View Notifications	13
Backlight activation gesture	13
Watch faces	14
Changing the watch face color theme	17
Menu	17
Quick settings	19
Pairing a phone with your watch	20
Before pairing a phone:	20
To pair a phone:	20
Delete a pairing	20
Updating the firmware	21
With phone or tablet	21
With computer	21
Settings	22
General settings	22
Pair and sync	22
Continuous HR tracking	22
Flight mode	22
Do not disturb	22
Phone notifications	22
Units	22
Language	22
Inactivity alert	23
Vibrations	23
I wear my watch on	23
About your watch	23
Physical settings	23
Weight	23
Height	23
Date of birth	23
Sex	23
Training background	23
Activity goal	24
Preferred sleep time	24

Maximum heart rate	24
Resting heart rate	24
VO2max	26
Watch settings	26
Alarm	26
Watch face	26
Time	26
Date	27
First day of week	27
Display icons	27
Restarting and resetting	27
To restart the watch	27
To reset the watch to factory settings	28
Training	29
Wrist-based heart rate measurement	29
Wearing your watch when measuring heart rate from your wrist or tracking your sleep	29
Wearing your watch when not measuring heart rate from your wrist or tracking your sleep/Nightly recharge	30
Start a training session	30
Start a planned training session	31
Quick menu	31
During training	33
Browse the training views	33
Set timers	34
Interval Timer	34
Countdown Timer	34
Training with a target	35
Change phase during a phased session	35
Notifications	35
Pausing/Stopping a training session	36
Training summary	36
After training	36
Training data in the Polar Flow App	37
Training data in the Polar Flow Web Service	38
Features	39
Connected GPS	39
To enable GPS via mobile phone	39
Smart Coaching	40
Nightly Recharge™ recovery measurement	40
ANS charge details in the Flow app	43
Sleep charge details in Polar Flow	43
For exercise	44
For sleep	44
For regulating energy levels	44
Sleep Plus Stages™ sleep tracking	45
FitSpark™ daily training guide	49
During training	51
Serene™ guided breathing exercise	52
Fitness Test with wrist-based heart rate	54
Before the test	55
Performing the test	55
Test results	55
Fitness level classes	55
Men	55
Women	56

VO2max	56
Polar Running Program	56
Create a Polar Running Program	57
Start a running target	57
Follow your progress	57
Cardio load	58
Training Benefit	58
Smart Calories	59
Continuous heart rate	60
Continuous heart rate on your watch	60
24/7 Activity tracking	61
Activity Goal	61
Activity data on your watch	61
Inactivity alert	62
Activity data in the Flow App and web service	62
Activity Benefit	62
Sport Profiles	63
Heart Rate Zones	63
Speed Zones	64
Speed zones settings	64
Training target with speed zones	64
During training	64
After training	64
Speed and distance from the wrist	64
Phone notifications	64
Set phone notifications on	65
Do not disturb	65
View notifications	65
Changeable wristbands	65
Changing the wristband	65
Compatible sensors	66
Polar H10 heart rate sensor	66
Polar H9 heart rate sensor	67
Pairing sensors with your watch	67
Pair a heart rate sensor with your watch	67
Polar Flow	68
Polar Flow App	68
Training data	68
Activity data	68
Sleep data	68
Sport profiles	68
Image sharing	68
Start using the Flow app	68
Polar Flow Web Service	69
Feed	69
Diary	69
Reports	69
Community	69
Programs	70
Sport profiles in Polar Flow	70
Add a sport profile	70
Edit a sport profile	71
Planning your training	72
Create a training plan with the Season Planner	72

Create a training target in the Polar Flow app and web service	73
Duration target	73
Distance target	73
Calorie target	74
Interval target	74
Phased target	74
Favorites	74
Sync the targets to your watch	75
Favorites	75
Add a Training Target to Favorites:	75
Edit a Favorite	75
Remove a favorite	75
Syncing	75
Sync with Flow mobile App	76
Sync with Flow web service via FlowSync	76
Important information	77
Battery	77
Battery lifetime and operational time	77
Charging the battery	77
Battery status and notifications	78
Battery status symbol	78
Battery notifications	78
Caring for your watch	79
Keep your watch clean	79
Take good care of the optical heart rate sensor	79
Storing	79
Service	79
Precautions	80
Interference During Training	80
Minimizing Risks When Training	80
Warning - Keep batteries out of reach of children	81
How to use your Polar product securely	81
Technical specification	82
Polar Unite	82
Polar FlowSync Software	83
Polar Flow mobile application compatibility	83
Water resistance of Polar products	83
Regulatory information	84
Limited International Polar Guarantee	84
Disclaimer	85

POLAR UNITE USER MANUAL

This user manual helps you get started with your new watch. To see video tutorials and FAQs, go to support.polar.com/en/unite.

INTRODUCTION

Congratulations on your new Polar Unite!

Polar Unite fitness watch helps you combine your training, recovery, and daily life for perfect balance. Polar Unite motivates you to stay consistent in your training and makes staying fit and healthy a natural part of your everyday life with its intelligent features. It comes with advanced wrist-based heart rate measurement. The [Sleep Plus Stages™](#) sleep tracking monitors your sleep stages (REM, light and deep sleep) and gives you sleep feedback and a numerical sleep score. [Nightly Recharge™](#) measures your recovery every night, and the [FitSpark™](#) training guide gives you personalized workout guidance based on your readiness. Polar Unite helps you relax and relieve stress with the [Serene™](#) guided breathing exercises, and you can connect Polar Unite [to your phone to use GPS](#). You can customize Polar Unite with different wristbands and watch face color themes. You can also use your Unite during [Polar Club](#) classes to broadcast your heart rate to the Polar Club system.

Sleep Plus Stages automatically tracks the **amount** and **quality** of your sleep and shows you how long you spent in each sleep stage. It gathers your sleep time and sleep quality components into one easily glanceable value, **sleep score**. Sleep score tells you how well you slept compared to the indicators of a good night's sleep based on the current sleep science. Comparing the components of the sleep score to your own usual level help you recognize which aspects of your daily routine may affect your sleep and may need adjusting.

Nightly Recharge™ is an overnight recovery measurement that shows you how well you recover from the demands of your day. Your **Nightly Recharge status** is based on two components: how you slept (**sleep charge**) and how well your autonomic nervous system (ANS) calmed down during the early hours of your sleep (**ANS charge**). Both components are formed by comparing your last night to your usual levels from the past 28 days. Your watch automatically measures both sleep charge and ANS charge during the night. Based on what we've measured from you, you get personalized daily tips in the Polar Flow app on exercise, and tips on sleep and regulating your energy levels on those particularly rough days.

The FitSpark™ training guide offers **daily on-demand workouts** easily available on your watch. The workouts are built to match your fitness level, training history and your recovery and readiness, based on your Nightly Recharge status from the previous night. FitSpark suggests 2-4 different workout options for you every day: one that suits you best and 1-3 other options to choose from. You get a maximum of four suggestions per day and there are 19 different workouts in total. Suggestions include workouts from **cardio**, **strength** and **supportive** training categories.

Serene™ breathing exercise is a stress management tool that helps you to relax your body and calm down your mind. It guides you towards slow diaphragmatic breathing that has proven health benefits. During the breathing exercise your watch gives you biofeedback on the harmony between your breathing and your heart's beat-to-beat intervals. It tracks the time you spend in the serenity zones – the time when slow breathing has successfully driven your heart in a beneficial synchrony with the rhythm of your breathing.

With the [changeable wristbands](#), you can personalize your watch to match every situation and style.



We are continuously developing our products for a better user experience. To keep your watch up to date and get the best performance, always make sure to [update the firmware](#) whenever a new version is available. The firmware updates enhance the functionality of your watch through improvements.

TAKE FULL ADVANTAGE OF YOUR POLAR UNITE

You can use your watch straight from the box but for the full Polar experience connect your watch to Polar Flow, our free app and web service.

Get the [Polar Flow app](#) from the App Store® or Google Play™. Sync your watch with the Flow app after training, and get an instant overview and feedback on your training results and performance and let all your friends know about your achievements. In the Flow app you can also check how you've slept and how active you've been during the day.

POLAR FLOW WEB SERVICE

Sync your training data to the [Polar Flow web service](#) with the FlowSync software on your computer or via the Flow app. In the web service you can plan your training, track your achievements, get guidance and see a detailed analysis of your training results, activity and sleep. Let all your friends know about your achievements, find fellow exercisers and get motivation from your social training communities.

Find all this at flow.polar.com

GET STARTED

SETTING UP YOUR WATCH

To wake up and charge your watch, plug it into a powered USB port or a USB charger with the USB charging adapter that came in the box. Align the pins of the USB charging adapter with the pins on the watch and snap the adapter into place. Also make sure that you plug the USB charging adapter in the right way around, i.e. **the contacts on the Polar Unite USB charging adapter must face the contacts in your computer's USB port or in the USB charger**. Please note that it may take a while for the charging animation to appear on the display. We recommend that you charge the battery before you start using your watch. See [Battery](#) for detailed information on charging the battery.

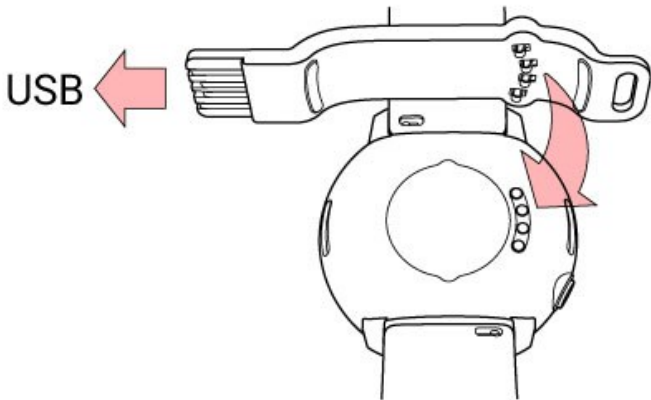

Attach the USB charging adapter to the watch **before** connecting the adapter to the power supply. Don't leave the USB charging adapter connected to the power supply **without** the watch.



To set up your watch, choose your language and preferred setup method. The watch gives you three options for setup: Browse to the option most convenient for you by swiping the display up or down. Tap the display to confirm your selection.

- A. **On your phone:** Mobile setup is convenient if you don't have access to a computer with a USB port, but it might take longer. This method requires an internet connection.
- B. **On your computer:** Wired computer setup is quicker and you can charge your watch at the same time, but you need a computer available. This method requires an internet connection.



The A and B options are recommended. You can fill in all the physical details required for accurate training data at once. You can also choose your language and get the latest firmware for your watch.

C. On your watch: If you don't have a compatible mobile device and can't get to a computer with an internet connection right away, you can start from the watch. **Please note that when you do the setup from the watch, your watch is not yet connected with Polar Flow. It's important that you do the setup later via option A or B to get the latest firmware updates to your Polar Unite.** In Flow you can also see a detailed analysis of your training, activity and sleep data. See [Using Polar Unite in stand-alone mode](#) for further information.



Polar Unite does not have a built-in GPS, but you can record the routes, speed and distance of your outdoor training sessions by using your mobile phone's GPS. To be able to use [connected GPS](#), you need to do the set up on your phone (A).

OPTION A: SET UP WITH A PHONE AND POLAR FLOW APP



Please note that you have to do the pairing in the Flow app and **NOT** in your phone's Bluetooth settings.

1. Keep your watch and phone close to each other during setup.
2. Make sure your phone is connected to the internet and turn on Bluetooth.
3. Download the Polar Flow app from the App Store or Google Play on your phone.
4. Open the Flow app on your phone.
5. The Flow app recognizes your watch nearby and prompts you to start pairing it. Tap the **Start** button on the Flow app.
6. When the **Bluetooth Pairing Request** confirmation message appears on your phone, check that the code shown on your phone matches the code shown on your watch.
7. Accept the Bluetooth pairing request on your phone.
8. Confirm the pin code on your watch by tapping the display.
9. **Pairing done** is displayed once the pairing is completed.
10. Sign in with your Polar account or create a new one. We'll walk you through the sign-up and setup within the app.

When you're done with the settings, tap **Save and sync** and your settings are synced to your watch.



If you're prompted to update the firmware, please plug your watch into a power source to ensure a flawless update operation, and then accept the update.

OPTION B: SET UP WITH YOUR COMPUTER

1. Go to flow.polar.com/start and download and then install the Polar FlowSync data transfer software onto your computer.
2. Sign in with your Polar account or create a new one. Plug your watch into your computer's USB port with the USB charging adapter that came in the box. We'll walk you through the sign-up and setup within the Polar Flow web service.

OPTION C: SET UP FROM THE WATCH

Adjust the values by swiping the display and tap to confirm your selection. If you want to return and change a setting at any point, press BACK until you reach the setting you want to change.



Please note that when you do the setup from the watch, your watch is not yet connected with Polar Flow. Firmware updates for your watch are available only through Polar Flow. To make sure you get to enjoy your watch and the unique Polar features at their best, it's important that you do the setup later in the Polar Flow web service or with the Polar Flow mobile app by following the steps in option A or B.

USING POLAR UNITE IN STAND-ALONE MODE

You can use the Polar Unite in stand-alone mode by choosing the **setup from the watch** option when taking it into use for the first time. If you use your Polar Unite in stand-alone mode, your watch is not connected with Polar Flow. Note that some features require the watch to be connected to Polar Flow, and are not available in stand-alone mode. To make sure you get to enjoy your watch and the unique Polar features at their best, we recommend that you do the setup later in the Polar Flow web service or with the Polar Flow mobile app.

FEATURES THAT ARE NOT AVAILABLE IN STAND-ALONE MODE

- [Firmware updates](#) for your watch
- [Connected GPS](#) via mobile phone
- Personal [training targets](#)

- Polar [Running program](#)
- [Activity benefit](#)
- [Training benefit](#)
- [Phone notifications](#)
- Adding new [sport profiles](#) to your watch
- Manual adjustment of [speed zones](#)

POLAR FLOW PROVIDES A DETAILED ANALYSIS OF YOUR TRAINING, ACTIVITY AND SLEEP DATA

- You'll get a [summary of your training session](#) on your watch right after you've stopped training. More detailed and illustrated analysis is available in the Polar Flow app or in the Polar Flow web service.



In stand-alone mode your watch shows your training sessions for the last 14 days. You can open these by tapping the **Latest training session** watch face. In typical use maximum 30 training sessions fit into the 14 day memory. If you connect your watch with Polar Flow, all training sessions you have recorded with your watch will be saved and you are able to access them in Polar Flow later on.

- You can see your progress towards your daily [activity](#) goal, steps taken so far, active time and calories you have burned from your watch. In Polar Flow you can also see how much time you have spent in different activity intensity levels and follow your **weekly** and **monthly** activity status in a clear, visual format. From the Activity timeline view in Polar Flow web service you can easily see all of your daily activity and health benefits with just one glimpse.
- The [Nightly Recharge](#) status on your watch tells you how restorative **last night** was. You can compare and analyze your Nightly Recharge details from **different nights** in the Polar Flow app.
- You can see your [sleep score and sleep details](#) from your watch for the **previous night** and how they compare to your 28 day average values. In Polar Flow app you can analyze your sleep habits on a **weekly** basis through detailed views of your sleep score, sleep structure and sleep rhythm. Sleep report in Polar Flow web service gives you a **long-term** view to your sleep patterns. You can choose to view your sleep details for a 1-month, 3-month or 6-month period.
- Only the latest [Fitness test](#) result is shown on the watch. In Polar Flow web service you can see all your test results and how your fitness level has changed over time.

HOW TO WEAR THE POLAR UNITE WRISTBAND

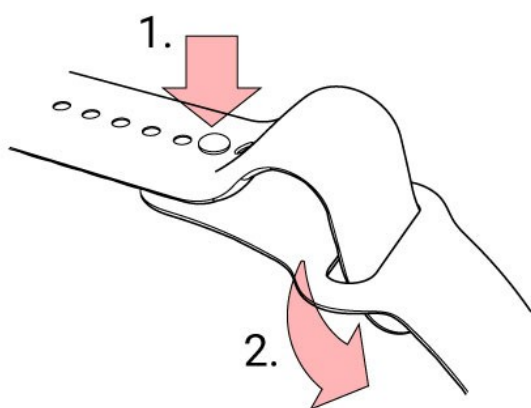

1. Push the pin into the hole.
2. Slide the excess strap underneath.







To measure wrist-based heart rate accurately during training or while tracking your sleep make sure that you wear the watch [correctly](#).



See detailed instructions for changing the wristband from [Changeable wristbands](#).

BUTTON FUNCTIONS AND TOUCH DISPLAY

Your watch has one button (BACK) that has different functionalities depending on the situation of use. See the table below to find out what functionalities the button has in different modes.

Time view	Menu	Pre-training mode	During training
			
Enter the menu	Return to the previous level	Return to time view	Pause training by pressing once. Tap the display to continue.
Press and hold to start pairing and syncing	Leave settings unchanged	Illuminate the display	To stop the session, press and hold when paused.
Illuminate the display	Cancel selections		Illuminate the display
Press and hold for 10 seconds to restart watch	Illuminate the display		

COLOR TOUCH DISPLAY

The color touch display lets you easily swipe between watch faces, through lists and menus, as well as choose items by tapping the display.

- Tap the display to confirm selections and choose items.
- Swipe up or down to scroll the menu.
- Swipe left or right during training to see different training views.
- Swipe left or right in time view to switch between the watch faces.
- Swipe down in time view to access the quick settings menu (screen lock, do not disturb, flight mode).
- Swipe up in time view to see notifications.
- Tap the display to see more detailed information.

To ensure proper function of the touch display wipe any dirt, sweat or water off the display with a cloth. The touch display won't respond properly when trying to use it while wearing gloves.



Display brightness can't be adjusted by the user.

VIEW NOTIFICATIONS

View the notifications by swiping up from the bottom of the display or by turning your wrist to look at the watch immediately after the watch vibrates. The red dot at the bottom of the display indicates you have new notifications. For more information, see [Phone notifications](#).

BACKLIGHT ACTIVATION GESTURE

The backlight is automatically switched on when you turn your wrist to look at the watch.

WATCH FACES

The Polar Unite watch faces tell you a lot more than just the time. You'll get the most timely and relevant information right on the watch face, including your activity status, your heart rate, latest training sessions, Nightly recharge status and FitSpark on-demand training suggestions. You can scroll through the watch faces by swiping left or right and open a more detailed view by tapping the watch face.



You can choose between an analogue and a digital display in [Watch settings](#).



Note that the watch faces and their contents cannot be edited, but you can change the [watch face color theme](#).

Time



Basic watch face with time and date.

Activity



The graph bar around the watch face and the percentage below the time and date show your progress towards your daily activity goal.

In addition, when opening the details, you can see the following details of your day's accumulated activity:

- Steps you've taken so far. The amount and type of body movements are registered and turned into an estimation of steps.
- Active time tells you the cumulative time of body movements that benefit your health.
- Calories you've burned through training, activity and BMR (Basal metabolic rate: the minimum metabolic activity required to maintain life).



For more information, see [24/7 Activity tracking](#).

Heart rate



When using the **Continuous heart rate** feature your watch continuously measures your heart rate and displays it on the Heart rate watch face.

When using the Continuous heart rate feature, you can also follow what are the highest and lowest heart rate readings of your day and you can check what your lowest heart rate reading was during the previous night. You can turn the Continuous heart rate feature on, off or to night-time only mode on your watch in **Settings > General settings > Continuous HR tracking**.



For more information, see [Continuous heart rate feature](#).



If you're not using the **Continuous heart rate** feature, you can still quickly check your current heart rate without starting a training session. Just tighten your wristband, choose this watch face and you'll see your current heart rate by tapping the display. Return to the Heart rate watch face by pressing BACK.



Latest training sessions



See the time passed since your latest training session and the sport of the session.

In addition, when opening the details, you can view the summaries of your training sessions from the last 14 days. Browse to the training session you want to view by swiping up/down, and then tap the display to open the summary. For more information, see [Training summary](#).



Nightly Recharge watch face



When you wake up you can see your **Nightly Recharge status**. Nightly Recharge status tells you how restorative your last night was. Nightly Recharge combines information on how well your autonomic nervous system (ANS) calmed down during the early hours of your sleep (**ANS charge**) and how well you slept (**sleep charge**). Tap ANS charge details or Sleep charge details for more information.

For more information, see [Nightly Recharge™ recovery measurement](#) or [Sleep Plus Stages™ sleep tracking](#).



FitSpark watch face



Your watch suggests the most suitable training targets for you based on your training history, fitness level and current recovery status. Tap the watch face to see all the suggested training targets. Tap one of the suggested training targets to see detailed information about the training target.

For more information, see [FitSpark daily training guide](#).



CHANGING THE WATCH FACE COLOR THEME

You can customize your Polar Unite by choosing a different watch face colors from a set of pre-defined options. Available color themes are red, orange, yellow, green, blue, purple and pink.



To change the watch face color theme, go to **Settings > Watch settings > Watch face > Digital/Analog > Color theme**.



Note that the watch faces and their contents cannot be edited apart from changing the watch face color theme.

MENU

Enter the menu by pressing BACK and browse through the menu by swiping up or down. Confirm selections by tapping the display, and return with the BACK button.

Start training



From here you can start your training sessions. Tap the display to enter the pre-training mode and browse to the sport profile you want to use.

See [Start a training session](#) for detailed instructions.

Settings



You can edit the following settings on your watch:

- Physical settings
- General settings
- Watch settings

For more information, see [Settings](#).





In addition to the settings available on your watch, you can edit Sport Profiles in the Polar Flow web service and app. Customize your watch with your favorite sports and the information you want to follow during your training sessions. See [Sport Profiles in Flow](#) for more information.

Timers



In **Timers** you'll find a stopwatch and a countdown timer.

Stopwatch

To start the stopwatch, tap first **Stopwatch** and then . To add a lap, tap the lap icon . To pause the stopwatch, press BACK.





Countdown Timer

You can set the countdown timer to count down from a preset time. Tap **Set Timer**, and set the countdown time, and tap  to confirm. When completed, tap **Start** to start the countdown timer.

The countdown timer is added to the basic watch face.



At the end of the countdown, the watch notifies you by vibrating. Tap  to restart the timer, or tap  to cancel and return to the time view.



During training you can use interval timer and countdown timer. Add the timer views to training views in the sport profile settings in Flow and sync the settings to your watch. For more information on using timers during training, see [During training](#).

Serene guided breathing exercise



First, tap **Serene** and then tap **Start exercise** to start the breathing exercise.

For more information, see [Serene™ guided breathing exercise](#).

Fitness Test



To perform the fitness test, first tap **Fitness Test**, and then tap **Relax and start the test**.

For more information, see [Fitness Test with wrist-based heart rate](#).

QUICK SETTINGS

Quick settings menu



Swipe down from the top of the screen to pull down the **Quick settings** menu. Swipe left or right to browse and tap to choose alarm, screen lock, do not disturb feature or flight mode :

- **Alarm:** Tap the alarm icon to adjust alarm settings.
- **Screen lock:** Tap the screen lock icon to switch screen lock on. Press the BACK button for 2 seconds to unlock the screen.
- **Do not disturb:** Tap the do not disturb icon to switch it on and tap again to switch it off. When do not disturb is switched on, you will not get any notifications or call alerts. Also, the backlight activation gesture is disabled.
- **Flight mode:** Tap the flight mode icon to switch it on and tap again to switch it off. Flight mode cuts off all wireless communication from your watch. You can still use it, but you can't sync your data with the Polar Flow mobile app or use it with any wireless accessories.

Battery status icon shows how much charge is left in the battery.

During training



- **Backlight** : Tap the Backlight icon to choose **Always on** or **Automatic**. With always on selected the watch display will be illuminated throughout your training session. The backlight setting will default back to automatic after you finish your training session. Please note that the always on selection will drain your battery much faster than the default setting.
- **Screen lock**: Tap the screen lock icon to switch screen lock on. Press the BACK button for 2 seconds to unlock the screen.

PAIRING A PHONE WITH YOUR WATCH

Before you can pair a phone with your watch, you need to setup your watch in the Polar Flow web service or with the Polar Flow mobile app as described in chapter [Setting up your watch](#). If you did the setup for your watch with a phone, your watch has already been paired. If you did the setup with a computer and would like to use your watch with Polar Flow app, please pair your watch and phone as follows:

BEFORE PAIRING A PHONE:

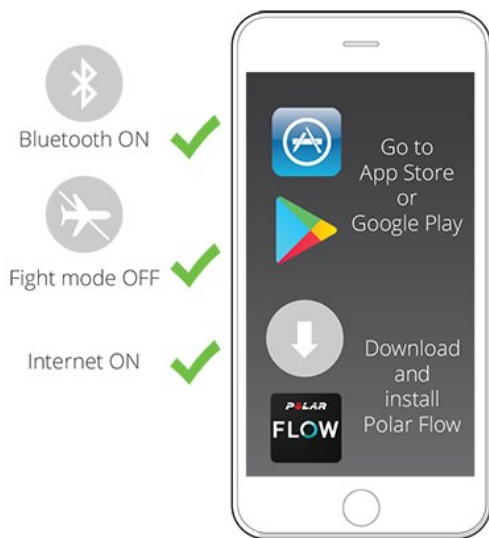

- Download Flow app from the App Store or Google Play.
- Make sure your phone has Bluetooth turned on, and airplane mode/flight mode is not turned on.
- **Android users:** make sure location is enabled for the Polar Flow app in the phone's application settings.

TO PAIR A PHONE:

1. On your phone, open the Flow app and sign in with your Polar account, which you have created when setting up your watch.



Android users: If you have several Flow app compatible Polar devices in use, make sure you have chosen Polar Unite as the active device in the Flow app. This way the Flow app knows to connect to your watch. In the Flow app, go to **Devices** and choose Polar Unite.

2. On your watch, press and hold BACK in time mode **OR** go to **Settings > General settings > Pair and sync > Pair and sync phone** and tap the display.
3. **Open Flow app and bring your watch close to phone** is displayed on your watch.
4. When the **Bluetooth Pairing Request** confirmation message appears on your phone, check that the code shown on your phone matches the code shown on your watch.
5. Accept the Bluetooth pairing request on your phone.
6. Confirm the pin code on your watch.
7. **Pairing done** is displayed once the pairing is completed.

DELETE A PAIRING

To delete a pairing with a phone:

1. Go to **Settings > General settings > Pair and sync > Paired devices** and tap the display.
2. Choose the device you want to remove by tapping its name on the display.
3. **Remove pairing?** is displayed. Confirm by tapping the display.
4. **Pairing removed** is displayed when you are done.

UPDATING THE FIRMWARE

To keep your watch up to date and to get the best performance, always make sure to update the firmware whenever a new version is available. Firmware updates are performed to improve the functionality of your watch.



You won't lose any data due to the firmware update. Before the update begins, the data from your watch is synced to the Flow web service.

WITH PHONE OR TABLET

You can update the firmware with your phone if you're using the Polar Flow mobile app to sync your training and activity data. The app will let you know if there's an update available and will guide you through it. We recommend that you plug the watch into a power source before starting the update to ensure a flawless update operation.



The wireless firmware update may take up to 20 minutes, depending on your connection.

WITH COMPUTER

Whenever a new firmware version is available, FlowSync will notify you when you connect the watch to your computer. The firmware updates are downloaded via FlowSync.

To update the firmware:

1. Plug your watch into your computer with the USB charging adapter that came in the box. Align the pins of the USB charging adapter with the pins on the watch and snap the adapter into place. Also make sure that you plug the USB charging adapter in the right way, i.e. **the four pins on the Polar Unite USB charging adapter must face the four pins in your computer's USB port or in the USB charger.**

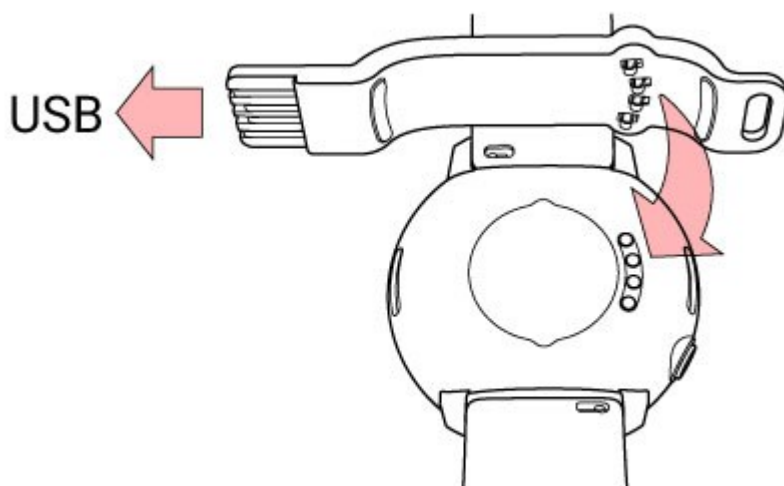

2. FlowSync starts syncing your data.
3. After syncing, you are asked to update the firmware.
4. Choose **Yes**. The New firmware is installed (this may take up to 10 minutes), and the watch restarts. Please wait until the firmware update has been finalized before you detach the watch from your computer.

SETTINGS

GENERAL SETTINGS

To view and edit your general settings, go to **Settings > General settings**.

In **General settings** you'll find:

- **Pair and sync**
- **Continuous HR tracking**
- **Flight mode**
- **Do not disturb**
- **Phone notifications**
- **Units**
- **Language**
- **Inactivity alert**
- **Vibrations**
- **I wear my watch on**
- **About your watch**

PAIR AND SYNC

- **Pair and sync phone/Pair sensor or other device:** Pair sensors or phones with your watch. Sync data with the Flow app.
- **Paired devices:** View all the devices you have paired with your watch. These can include heart rate sensors and phones.

CONTINUOUS HR TRACKING

Turn the Continuous Heart Rate feature **On**, **Off** or **Night-time only**. For more information, see [Continuous heart rate](#).

FLIGHT MODE

Choose **On** or **Off**.

Flight mode cuts off all wireless communication from your watch. You can still use it, but you can't sync your data with the Polar Flow mobile app or use it with any wireless accessories.

DO NOT DISTURB

Turn the Do not disturb feature **On**, **Off** or **On (-)**. Set the period when do not disturb is on. Choose when it **Starts at** and **Ends at**. When it is set on, you will not get any notifications or call alerts. Also, the backlight activation gesture is disabled.

PHONE NOTIFICATIONS

Set phone notifications **Off** or **On, when not training**. Note that you will not receive any notifications during training sessions.

UNITS

Choose metric (**kg**, **cm**) or imperial (**lb**, **ft**). Set the units used to measure weight, height, distance and speed.

LANGUAGE

You can choose the language you want to use on your watch. Your watch supports the following languages: **Bahasa Indonesia**, **Čeština**, **Dansk**, **Deutsch**, **English**, **Español**, **Français**, **Italiano**, **Nederlands**, **Norsk**, **Polski**, **Português**, **Русский**, **Suomi**, **Svenska**, **简体中文**, **日本語** and **Türkçe**.

INACTIVITY ALERT

Set the inactivity alert **On** or **Off**.

VIBRATIONS

Set vibrations for scrolling menu items **On** or **Off**.

I WEAR MY WATCH ON

Choose **Left hand** or **Right hand**.

ABOUT YOUR WATCH

Check the device ID of your watch, as well as the firmware version, HW model and the Polar Unite-specific regulatory labels.

Restart your watch: If you experience problems with your watch, you can try restarting it. Restarting the watch will not delete any of the settings or your personal data from the watch. Tap the display to restart and tap again to confirm the restart. You can also restart your watch by pressing and holding the BACK button for 10 seconds.

PHYSICAL SETTINGS

To view and edit your physical settings, go to **Settings > Physical settings**. It is important that you are precise with the physical settings, especially when setting your weight, height, date of birth and sex, as they have an impact on the accuracy of the measuring values, such as the heart rate zone limits and calorie expenditure.

In **Physical settings** you'll find:

- **Weight**
- **Height**
- **Date of birth**
- **Sex**
- **Training background**
- **Activity goal**
- **Preferred sleep time**
- **Maximum heart rate**
- **Resting heart rate**
- **VO₂max**

WEIGHT

Set your weight in kilograms (kg) or pounds (lbs).

HEIGHT

Set your height in centimeters (metric) or in feet and inches (imperial).

DATE OF BIRTH

Set your birthday. The order in which the date settings are depends on which time and date format you have chosen (24h: day - month - year/12h: month - day - year).

SEX

Select **Male** or **Female**.

TRAINING BACKGROUND

Training background is an assessment of your long-term physical activity level. Select the alternative that best describes the overall amount and intensity of your physical activity during the past three months.

- **Occasional (0-1h/week):** You do not participate regularly in programmed recreational sport or heavy physical activity, e.g. you walk only for pleasure or exercise hard enough to cause heavy breathing or perspiration only occasionally.
- **Regular (1-3h/week):** You participate regularly in recreational sports, e.g. you run 5-10 km or 3-6 miles per week or spend 1-3 hours per week in comparable physical activity, or your work requires modest physical activity.
- **Frequent (3-5h/week):** You participate at least 3 times a week in heavy physical exercise, e.g. you run 20-50 km/12-31 miles per week or spend 3-5 hours per week in comparable physical activity.
- **Heavy (5-8h/week):** You participate in heavy physical exercise at least 5 times a week, and you may sometimes take part in mass sports events.
- **Semi-pro (8-12h/week):** You participate in heavy physical exercise almost daily, and you exercise to improve performance for competitive purposes.
- **Pro (>12h/week):** You are an endurance athlete. You participate in heavy physical exercise to improve your performance for competitive purposes.

ACTIVITY GOAL

Daily activity goal is a good way to find out how active you really are in your everyday life. Choose your typical activity level from three options and see how active you need to be to reach your daily activity goal.

The time you need to complete your daily activity goal depends on the level you have chosen and the intensity of your activities. Age and gender also affect the intensity you need to reach your daily activity goal.

Level 1

If your day includes only a little sports and a lot of sitting, commuting by car or public transport and so on, we recommend you pick this activity level.

Level 2

If you spend most of your day on your feet, perhaps due to the type of work you do or your daily chores, this is the right activity level for you.

Level 3

If your work is physically demanding, you're into sports or otherwise tend to be on the move and active, this is the activity level for you.

PREFERRED SLEEP TIME

Set **Your preferred sleep** time to define how long you aim to sleep every night. By default, it is set to the average recommendation for your age group (eight hours for adults from 18 to 64 years). If you feel that eight hours of sleep is too much or too little for you, we recommend you adjust your preferred sleep time to meet your individual needs. By doing this, you'll get accurate feedback on how much sleep you got in comparison to your preferred sleep time.

MAXIMUM HEART RATE

Set your maximum heart rate, if you know your current maximum heart rate value. Your age-predicted maximum heart rate value ($220 - \text{age}$) is displayed as a default setting when you set this value for the first time.

HR_{\max} is used to estimate energy expenditure. HR_{\max} is the highest number of heartbeats per minute during maximum physical exertion. The most accurate method for determining your individual HR_{\max} is to perform a maximal exercise stress test in a laboratory. HR_{\max} is also crucial when determining training intensity. It is individual and depends on age and hereditary factors.

RESTING HEART RATE

Your resting heart rate is the lowest number of heartbeats per minute (bpm) when fully relaxed and without distractions. Your age, fitness level, genetics, health status and sex affect the resting heart rate. A typical value for an adult is 55–75 bpm, but your resting heart rate can be significantly lower than that, for example, if you're very fit.

It's best to measure your resting heart rate in the morning after a good night's sleep, right after you wake up. It's OK to go to the bathroom first if it helps you to relax. Don't do any strenuous training leading up to the measurement and make sure you're fully recovered from any activity. You should do the measurement more than once, preferably on consecutive mornings, and calculate your average resting heart rate.

To measure your resting heart rate:

1. Wear your watch. Lie down on your back and relax.
2. After about 1 minute, start a training session on your wearable. Choose any sport profile, for example Other indoor.
3. Lie still and breathe calmly for 3–5 minutes. Don't look at your training data during the measurement.
4. Stop the training session on your Polar device. Sync the wearable with the Polar Flow app or web service and check the training summary for the value of your lowest heart rate (HR min)—this is your resting heart rate. Update your resting heart rate to your physical settings in Polar Flow.

VO₂MAX

Set your VO₂max.

VO₂max (maximal oxygen uptake, maximal aerobic power) is the maximal rate at which oxygen can be used by the body during maximal exercise; it is related directly to the maximal capacity of the heart to deliver blood to the muscles. VO₂max can be measured or predicted by fitness tests (e.g. maximal exercise tests and submaximal exercise tests). You can use the [Polar Fitness Test](#) with wrist-based heart rate feature to estimate your VO₂max and update it to your physical settings.

WATCH SETTINGS

To view and edit your watch settings, go to **Settings > Watch settings**

In **Watch settings** you'll find:

- Alarm
- Watch face
- Time
- Date
- First day of week

ALARM

Set alarm repetition: **Off**, **Once**, **Monday to Friday** or **Every day**. If you choose **Once**, **Monday to Friday** or **Every day**, also set the time for the alarm. You can access the alarm settings also from the [Quick settings](#) menu.



When the alarm is set on, a clock icon is displayed in the time view.

WATCH FACE

Choose the watch face:

- Analog
- Digital

To change the watch face color theme, tap **Watch face color theme**.



Note that the watch faces and their contents cannot be edited apart from changing the watch face color theme.

TIME

Set the time format: **24 h** or **12 h**. Then set the time of day.



When syncing with the Flow app and web service, the time of day is automatically updated from the service.

DATE

Set the date. Also set the **Date format**, you can choose **mm/dd/yyyy**, **dd/mm/yyyy**, **yyyy/mm/dd**, **dd-mm-yyyy**, **yyyy-mm-dd**, **dd.mm.yyyy** or **yyyy.mm.dd**.



When syncing with the Flow app and web service, the date is automatically updated from the service.

FIRST DAY OF WEEK

Choose the starting day of each week. Choose **Monday**, **Saturday** or **Sunday**.



When syncing with the Flow app and web service, the week's starting day is automatically updated from the service.

DISPLAY ICONS



Flight mode is on. Flight mode cuts off all wireless communication from your watch. You can still use it, but you can't sync your data with the Polar Flow mobile app or use it with any wireless accessories.



Do not disturb mode is on. When do not disturb is switched on, you will not get any notifications or call alerts. Also, the backlight activation gesture is disabled.



Vibrating alarm is set. To set the alarm, go to **Settings > Watch settings > Alarm**.



Your paired phone is disconnected and you have notifications turned on. Check that your phone is within Bluetooth range from your watch and Bluetooth is enabled on your phone.



Screen lock is on. Press the BACK button for 2 seconds to unlock the screen.

RESTARTING AND RESETTING

If you experience problems with your watch, you can try restarting it. Restarting the watch will not delete any of the settings or your personal data from the watch.

TO RESTART THE WATCH

On your watch, press the BACK button, swipe up until you find **Settings**, navigate to **Settings > General settings > About your watch > Restart your watch**. First, tap **Restart your watch** and then tap  to confirm the restart.

You can also restart your watch by pressing and holding the BACK button for 10 seconds.

TO RESET THE WATCH TO FACTORY SETTINGS

If restarting your watch didn't help, you can reset the watch back to factory settings. Note that resetting the watch back to factory settings empties all personal data and settings from the watch, and you will need to set it up again for your personal use. All data that you have synced from your watch to your Flow account is safe.

1. Go to flow.polar.com/start and download and then install the Polar FlowSync data transfer software onto your computer.
2. Connect your watch to the computer's USB port.
3. Open settings in FlowSync.
4. Press the **Factory Reset** button.
5. If you use Flow app to sync, check the list of paired Bluetooth devices on your phone, and remove your watch from the list if it's there.

Now you need [to set up](#) your watch again, either via mobile or computer. Just remember to use the same Polar account in the setup you've used before resetting.



If you don't have computer in use, or the the reset via computer doesn't work out you can also reset your watch from the device itself: Press and hold the watch button continuously for 10 seconds until a Polar logo is shown. Wait for the watch to restart, then repeat this process 10-12 times. When factory reset has been completed, your watch will ask you to select your language.

TRAINING

WRIST-BASED HEART RATE MEASUREMENT

Your watch measures your heart rate from the wrist with the **Polar Precision Prime™** sensor fusion technology. This heart rate innovation combines optical heart rate measurement with skin contact measurement, ruling out any disturbances to the heart rate signal. It tracks your heart rate accurately even in the most demanding conditions and training sessions.

Although there are many subjective clues as to how your body is doing during exercise (perceived exertion, breathing rate, physical sensations), none of them are as reliable as measuring heart rate. It is objective and affected by both internal and external factors—meaning that you will have a dependable measure of your physical state.

WEARING YOUR WATCH WHEN MEASURING HEART RATE FROM YOUR WRIST OR TRACKING YOUR SLEEP

To measure wrist-based heart rate accurately during training, when using the [Continuous heart rate](#) and [Nightly Recharge](#) features or while tracking your sleep with [Sleep Plus Stages](#) make sure that you wear the watch correctly:

- Wear your watch on top of your wrist, at least a finger's width up from the wrist bone (see the picture below).
- Tighten the wristband firmly around your wrist. The sensor on the back must be in constant touch with your skin and the watch should not be able to move on your arm. A good way to check that the wristband is not too loose is if you push the wristband lightly up from both sides of your arm and make sure the sensor doesn't lift from your skin. When pushing the wristband up you shouldn't see the LED light shining from the sensor.
- For most accurate heart rate measurement, we advise you to wear your watch for a few minutes prior to starting the heart rate measurement. Also it's a good idea to warm up the skin if your hands and skin get cold easily. Get the blood going before starting your session!

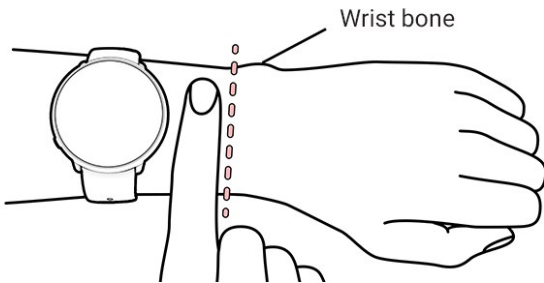

During training you should slide the Polar device further up from the wrist bone and wear the wristband a bit more tightly to try to minimize any extra moving of the device. Give your skin a few minutes to adapt to the Polar device before starting a training session. After the training session, loosen the wristband a bit.

If you have tattoos on the skin of your wrist, avoid placing the sensor right on them as they may prevent accurate readings.

In sports where it's more challenging to keep the sensor stationary on your wrist or where you have pressure or movement in muscles or tendons near the sensor, we recommend using a Polar heart rate sensor with a chest strap if you're looking for supreme accuracy in your training. Your watch is compatible with Bluetooth® heart rate sensors, like Polar H10 and Polar H9. The Polar H10 and H9 heart rate sensors are more responsive to rapidly increasing or decreasing heart rate, so they are an ideal option also for interval type of training with quick sprints.



To maintain the best possible performance of the wrist-based heart rate measurement, keep your watch clean and prevent scratches. After a sweaty training session, we recommend that you wash the watch under running water with a mild soap and water solution. Then wipe it dry with a soft towel. Let it fully dry before charging.

WEARING YOUR WATCH WHEN NOT MEASURING HEART RATE FROM YOUR WRIST OR TRACKING YOUR SLEEP/NIGHTLY RECHARGE

Loosen the wristband a bit for a more comfortable fit and to let your skin breathe. Wear the watch just as you would wear a normal watch.



Every once in a while it's a good idea to let your wrist have a breather, especially if you have sensitive skin. Take off your watch and recharge it. This way both your skin and your watch can have a rest, and be ready for your next training event.

START A TRAINING SESSION

1. [Wear your watch](#) and tighten the wristband.
2. To enter the pre-training mode press BACK to enter the main menu and tap **Start training**.



From the pre-training mode, you can access the quick menu by tapping the quick menu icon . The options displayed in the quick menu depend on the sport you have chosen and whether you are using GPS.

You can, for example, choose a favorite training target you want to perform and add timers to your training views. For more information, see [Quick menu](#).

After your choice, the watch returns to the pre-training mode.

3. Browse to your preferred sport.
4. Stay in the pre-training mode until the watch has found your heart rate and the GPS satellite signals (if applicable to your sport) to make sure your training data is accurate.
5. To catch GPS satellite signals:
 - Go outside with your mobile phone and watch away from tall buildings and trees.
 - Open Flow app and keep the mobile phone next to your watch.
 - Keep your watch still and avoid touching the watch during the GPS signal search.



Polar Unite doesn't have a built-in GPS, but you can record the routes, speed, pace and distance of your outdoor training sessions using your mobile phone's GPS. See [Connected GPS](#) for instructions how to enable GPS via mobile phone.



If you have paired an optional Bluetooth sensor with your watch, the watch will automatically start searching for the sensor signal as well.



The circle around the connected GPS icon will turn green when the GPS is ready. The watch notifies you with a vibration.



The watch has found your heart rate when your heart rate is shown.



When you're wearing a Polar heart rate sensor that's paired with your watch, the watch automatically uses the connected sensor to measure your heart rate during training sessions. A blue circle around the heart rate symbol indicates that your watch uses the connected sensor to measure your heart rate.

6. When all signals are found, tap the display to start training recording.

See [During Training](#) for more information on what you can do with your watch during training.

START A PLANNED TRAINING SESSION

You can plan your training and [create detailed training targets](#) in the Polar Flow app or the Polar Flow web service and sync them to your watch.

To start a planned training session scheduled for the current day:

1. Enter the pre-training mode by first pressing the BACK button and then tapping on **Start training**.
2. You'll be prompted to start a training target you've scheduled for the day.



3. Tap  to view the target information.
4. Tap **Start** to return to pre-training mode, and choose the sport profile you want to use.
5. When the watch has found all the signals, tap the display. **Recording started** is displayed and you can start training.

Your watch will guide you towards completing your target during training. See [During Training](#) for more information.



Your planned training targets will also be included in the [FitSpark](#) training suggestions.

QUICK MENU

You can access the quick menu by tapping the quick menu icon  from pre-training mode and during a session when paused.



The options displayed in the quick menu depend on the sport you have chosen and whether you are using GPS.



Training suggestions:

Training suggestions shows you the daily [FitSpark](#) training suggestions.



Favorites:

In Favorites you'll find training targets that you have saved as favorites in the Flow web service, and synced to your watch. Choose a favorite training target you want to perform. After your choice, the watch returns to the pre-training mode where you can start the training session.

For more information, see [Favorites](#).



Interval timer:

You can set time and/or distance based interval timers to precisely time work and recovery phases in your interval training sessions.

To add interval timer to your training views for the session, choose **Timer for this session > On**. You can use a previously set timer or create a new timer by returning to the quick menu and choosing **Interval timer > Set timers**:

1. Choose **Time-based** or **Distance-based**: **Time-based**: Define minutes and seconds for the timer and tap . **Distance-based**: Set the distance for the timer and tap . **Set another timer?** is shown. To set another timer, tap .
2. When completed, the watch returns to pre-training mode where you can start the training session. The timer starts when you start the training session.

For more information, see [During Training](#).



Countdown timer:

To add countdown timer to your training views for the session, choose **Timer for this session > On**. You can use a previously set timer or create a new timer by returning to the quick menu and choosing **Countdown timer > Set timer**. Set the countdown time, and tap to confirm. When completed, the watch returns to pre-training mode where you can start the training session. The timer starts when you start the training session.

For more information, see [During Training](#).

When you choose a training target for your session, the **Favorites** and **Training suggestions** options are crossed out in the quick menu. This is because you can only choose one target for the session. To change the target, choose the crossed out option and you will be asked if you want to change your target. Confirm another target by tapping .

DURING TRAINING

BROWSE THE TRAINING VIEWS

During training you can browse through the training views by swiping the display left or right. Note that the available training views and the information you see on the training views depend on the sport you've chosen and on any edits you've done to the chosen sport profile.

You can add sport profiles onto your watch and define the settings for each sport profile in the Polar Flow app and web service. You can create tailored training views for each sport you do and choose what data you want to follow during your sessions. For more information, see [Sport profiles in Flow](#).

For example, your training views can have the following information:



Your heart rate and the heart rate ZonePointer

Distance

Duration

Pace/Speed



Your heart rate and the heart rate ZonePointer

Duration

Calories



Maximum heart rate

Heart rate graph and your current heart rate

Average heart rate

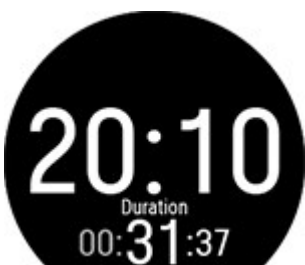

Time of day

Duration



Backlight always on during training: Swipe down from the top of the screen to pull down the [Quick settings](#) menu. Tap the Backlight icon to select **Always on** or **Automatic**. With always on selected the watch display will be illuminated throughout your training session. The backlight setting will default back to automatic after you finish your training session. Please note that the always on selection will drain your battery much faster than the default setting.

SET TIMERS

Before you can use timers during training, you need to add the timers to your training views. You can do this either by setting the timer view on for your current training session from the [Quick menu](#) or by adding the timers to the training views of the sport profile in the Flow web service sport profile settings and syncing the settings to your watch.

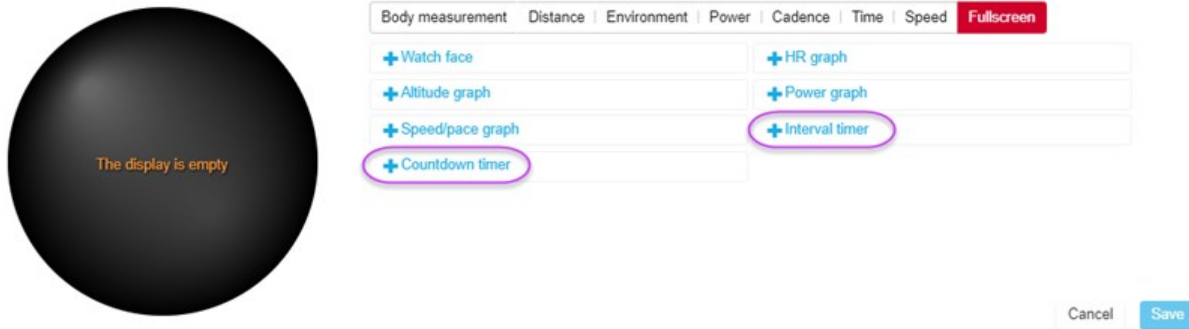

See [Sport Profiles in Flow](#) for more information.

INTERVAL TIMER



If you set the timer view on for your training session from the [Quick menu](#), the timer starts when you start the training session. You can stop the timer and start a new timer as instructed below.

If you have added the timer in the training views of the sport profile you are using, you can start the timer as follows:

1. Browse to the **Interval timer** view and press and hold the display for 3 seconds. Tap **Start** to use a previously set timer or create a new timer in **Set interval timer**.
2. Choose **Time-based** or **Distance-based**: **Time-based**: Define minutes and seconds for the timer and tap . **Distance-based**: Set the distance for the timer and tap .
3. **Set another timer?** is shown. To set another timer, tap .
4. When completed, tap **Start** to start the interval timer. At the end of each interval, the watch notifies you by vibrating.

To stop the timer, press and hold the display for 3 seconds and tap **Stop timer**.

COUNTDOWN TIMER

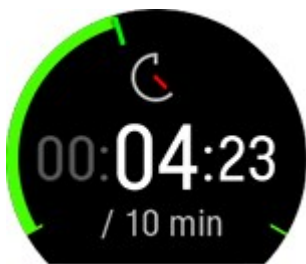



If you set the timer view on for your training session from the [Quick menu](#), the timer starts when you start the training session. You can stop the timer and start a new timer as instructed below.

If you have added the timer to the training views of the sport profile you are using, start the timer as follows:

1. Browse to the **Countdown timer** view and press and hold the display for 3 seconds.
2. Tap **Start** to use a previously set timer or choose **Set countdown timer** to set a new countdown time. When completed, tap **Start** to start the countdown timer.
3. At the end of the countdown, the watch notifies you by vibrating. If you want to restart the countdown timer, press and hold the display for 3 seconds and tap **Start**.

TRAINING WITH A TARGET

If you have created a **quick training target** based on duration, distance or calories in the Flow app or web service and synced it to your watch, you have the following training target view as the default first training view:

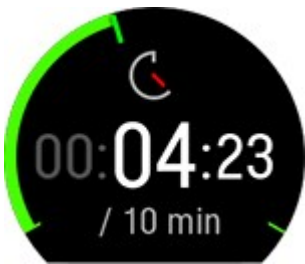

If you've created a target based on duration or distance, you can see how much of your target you still have remaining before you reach it.

OR

If you've created a target based on calories, you can see how many calories of your target you have left to burn.

If you have created a **phased training target** in the Flow app or web service and synced the target to your watch, you have the following training target view as the default first training view:



- Depending on the chosen intensity, you can see either your heart rate or speed/pace and the lower and upper heart rate or speed/pace limit of the current phase.
- Phase name and phase number/total number of phases
- Duration/distance covered so far
- Target duration/distance of the current phase



Your planned training targets will also be included in the [FitSpark](#) training suggestions.



See [Planning your training](#) for instructions on creating training targets.

CHANGE PHASE DURING A PHASED SESSION

The phase will change automatically when you have finished a phase. The watch notifies you by vibrating when the phase changes.

NOTIFICATIONS

If you are training outside the planned heart rate zones or speed/pace zones, your watch notifies you with a vibration.

PAUSING/STOPPING A TRAINING SESSION



Press BACK to pause your training session.

Tap the sport icon to continue training. To stop the session, press and hold BACK. You'll get a summary of your training session on your watch right after you've stopped training.



If you stop your session after pausing, the time elapsed after pausing is not included in the total training time.

TRAINING SUMMARY

AFTER TRAINING

You'll get a summary of your training session on your watch right after you've stopped training. Get a more detailed and illustrated analysis in the Polar Flow app or in the Polar Flow web service.

The information shown in your summary depends on the sport profile and data collected. For example, your training summary can include the following information:



Start time and date

Duration of the session

Distance covered in the session



Heart rate

Your average and maximum heart rate during the session.

Your Cardio load from the session.



Heart rate zones

Training time spent in different heart rate zones



Calories

Calories burned during the session

Fat burn % of calories: Calories expended from fat during a workout expressed as a percentage of the total calories burned during the session



Pace/Speed

Average and maximum pace/speed of the session



Speed zones

Training time spent in different speed zones



Altitude

Maximum altitude during the session

Ascended meters/feet during the session

Descended meters/feet during the session

To view your training summaries later on your watch:



In time view, swipe left or right to navigate to the **Latest training sessions** watch face, and then tap the display.

You can view the summaries of your training sessions from the last 14 days. Browse to the training session you want to view by swiping up or down and tap the training session to open the summary. Your watch can contain a maximum of 20 training summaries.

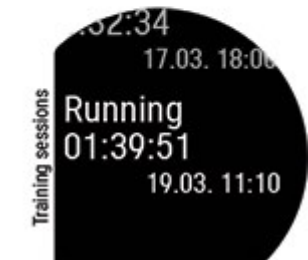

TRAINING DATA IN THE POLAR FLOW APP

Your watch syncs with the Polar Flow app automatically after you finish a training session if your phone is within the Bluetooth range. You can also sync your training data manually from the watch to the Flow app by pressing and holding

the BACK button of your watch when you're signed in to the Flow app and your phone is within the Bluetooth range. In the app you can analyze your data at a glance after each session. The app allows you to see a quick overview of your training data.

For more information, see [Polar Flow App](#).

TRAINING DATA IN THE POLAR FLOW WEB SERVICE

Analyze every detail of your training and learn more about your performance. Follow your progress and also share your best sessions with others.

For more information, see [Polar Flow Web Service](#).

FEATURES

CONNECTED GPS

You can record the route, speed, pace and distance of your outdoor training sessions with your Polar Unite, using your mobile phone's GPS. You need to have the Polar Flow mobile app on your mobile phone, have your phone paired with your watch, and also give the Flow app permission to use your phone's location. You only need to perform these steps once, when using connected GPS for the first time. On subsequent training sessions, you don't need to give permission anymore, just keep your mobile phone with you.

When you open the Polar Flow app for the first time, you are asked to allow Polar Flow to use your mobile phone's location. Choose **Always Allow** on iOS phones or **Allow all the time** on Android phones.

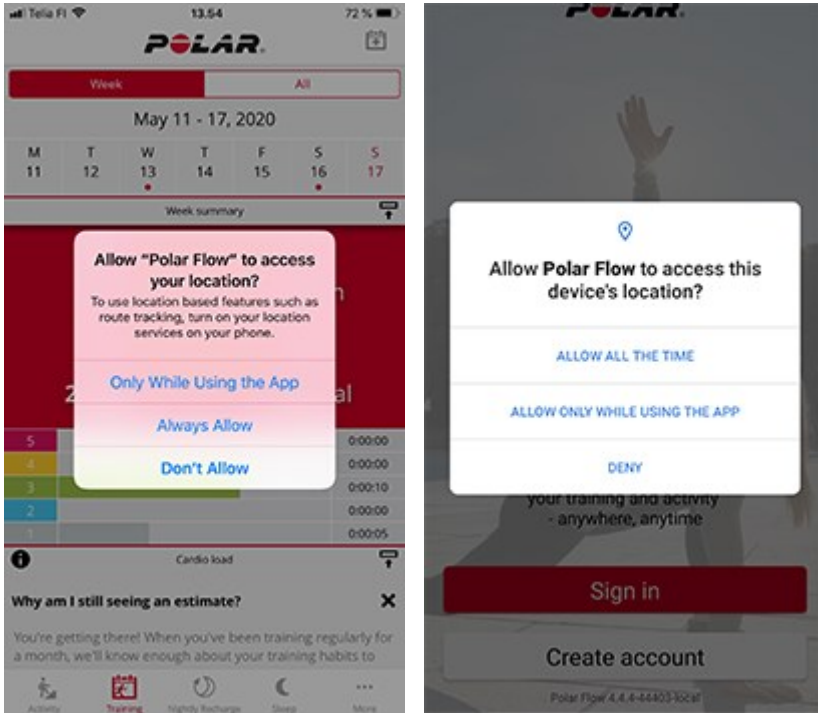

If you need to adjust the location permissions later on you can access them by navigating to:

iOS: Settings > Privacy > Location services > Polar Flow.

Android: Go to Settings, look for application permissions. Grant the location permission for Polar Flow app. In some Android phones the path is Settings > Apps & notifications > Permissions.

TO ENABLE GPS VIA MOBILE PHONE

1. Go outside with your mobile phone and watch.
2. Open the Flow app and keep the mobile phone next to your watch.
3. Press the BACK button to enter the main menu, tap **Start training** and navigate to an outdoor sport.
4. The circle around the connected GPS icon will turn green when the GPS is ready and your watch also notifies you with a vibration.
5. Tap the display to start training recording.



You need to keep your mobile device with you during the training session. Note that the accuracy of the positioning data depends on the accuracy of the mobile phone's GPS. It may vary depending on the mobile phone you use.

SMART COACHING

Whether it's assessing your day-to-day fitness levels, creating individual training plans, working out at the right intensity or receiving instant feedback, Smart Coaching offers a choice of unique, easy-to-use features, personalized to your needs and designed for maximum enjoyment and motivation when training.

Your watch includes the following Polar Smart Coaching features:

- [Nightly Recharge™ recovery measurement](#)
- [Sleep Plus Stages™ sleep tracking](#)
- [FitSpark™ daily training guide](#)
- [Serene™ guided breathing exercise](#)
- [Fitness Test](#)
- [Running Program](#)
- [Cardio load](#)
- [Training benefit](#)
- [Smart calories](#)
- [Continuous heart rate](#)
- [24/7 Activity tracking](#)
- [Activity Benefit](#)

NIGHTLY RECHARGE™ RECOVERY MEASUREMENT

Nightly Recharge™ is an overnight recovery measurement that shows you how well you recover from the demands of your day. Your **Nightly Recharge status** is based on two components: how you slept (**sleep charge**) and how well your autonomic nervous system (ANS) calmed down during the early hours of your sleep (**ANS charge**). Both components are formed by comparing your last night to your usual levels from the past 28 days. Your watch automatically measures both sleep charge and ANS charge during the night.

You can see your Nightly Recharge status on your watch and in the Polar Flow app. Based on what we've measured from you, you get personalized daily tips in Polar Flow app on exercise, and tips on sleep and regulating your energy levels on those particularly rough days. Nightly Recharge helps you make optimal choices in your everyday life to maintain overall well-being and reach your training goals.

How to start using Nightly Recharge?



1. Continuous heart rate tracking needs to be enabled for Nightly Recharge to function. To enable Continuous HR tracking go to **Settings > General Settings > Continuous HR tracking** and choose **On** or **Night-time only**.
2. Tighten the wristband firmly around your wrist and wear the watch when you sleep. The sensor on the back of the watch must be in constant touch with your skin. For more detailed wearing instructions, see [Wrist-based heart rate measurement](#).
3. You need to wear your watch for **three nights** before you start to see the Nightly Recharge status on your watch. This is how long it takes to establish your usual level. Before you get your Nightly Recharge you can view your sleep and ANS measurement details (heart rate, heart rate variability and breathing rate). After three successful nightly measurements you can see your Nightly Recharge status on your watch.

Nightly Recharge on your watch

Already awake? is shown on the Nightly Recharge watch face when your watch has detected a minimum of four hours of sleep. Confirm by tapping  and the watch summarizes your Nightly Recharge instantly. The Nightly Recharge status tells you how restorative last night was. Scores for both **ANS charge** and **sleep charge** are taken into account when calculating your Nightly Recharge status. Nightly Recharge status has the following scale: very poor – poor – compromised – OK – good – very good. In time view, swipe left or right to navigate to the Nightly Recharge watch face.



Tap the Nightly Recharge watch face to see further information about your **ANS charge** and your **sleep charge**.



1. Nightly Recharge status graph
2. Nightly Recharge status Scale: very poor – poor – compromised – OK – good – very good.
3. ANS charge graph
4. ANS charge The scale is from -10 to +10. Around zero is your usual level.
5. ANS charge status Scale: much below usual – below usual – usual – above usual – much above usual.
6. Heart rate bpm (4 h average)
7. Beat-to-beat interval ms (4 h average)
8. Heart rate variability ms (4 h average)
9. Breathing rate br./min (4 h average)
10. Sleep score graph
11. Sleep score (1 - 100) A score that summarizes your sleep time and sleep quality into a single number.
12. Sleep charge status = Sleep score compared to your usual level. Scale: much below usual – below usual – usual – above usual – much above usual.
13. Sleep data details. See "Sleep data on your watch" on page 45 for more detailed information.

Nightly Recharge in the Flow app

You can compare and analyze your Nightly Recharge details from different nights in the Polar Flow app. Choose **Nightly Recharge** from the Flow app menu to see the details of your last night's Nightly Recharge. Swipe the display right to see the Nightly Recharge details for previous days. Tap the **ANS charge** or **sleep charge** box to open detailed view of ANS charge or sleep charge.

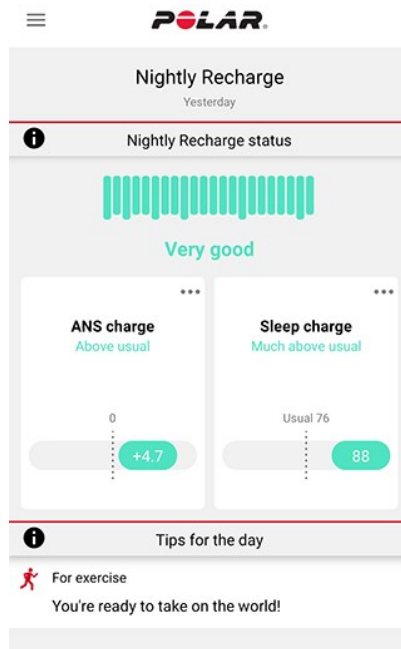
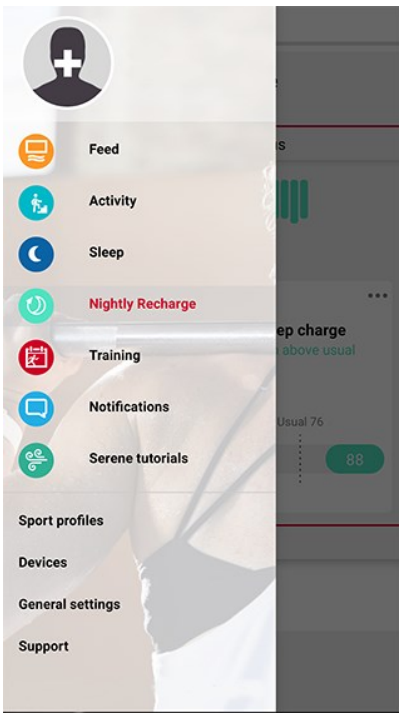

ANS charge details in the Flow app

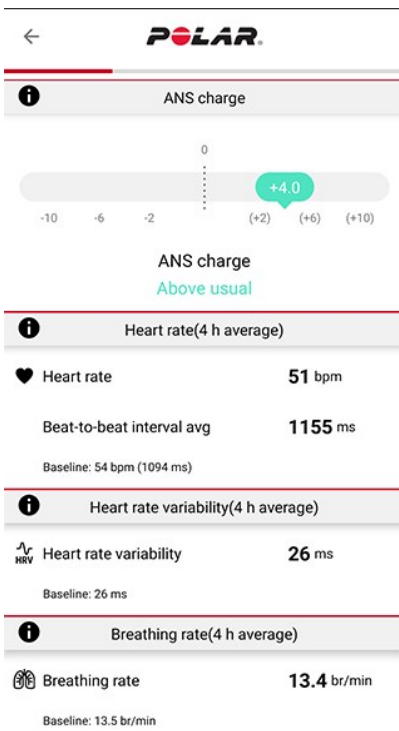

ANS charge gives you information on how well your autonomic nervous system (ANS) calmed down during the night. The scale is from -10 to +10. Around zero is your usual level. The ANS charge is formed by measuring your **heart rate**, **heart rate variability** and **breathing rate** during roughly the first four hours of sleep.

A normal **heart rate** value for adults can range between 40 and 100 bpm. It is common for your heart rate values to vary between nights. Mental or physical stress, exercising late at night, illness, or alcohol can keep your heart rate up during the early hours of your sleep. It's best to compare your last night's value to your usual level.

Heart rate variability (HRV) refers to the variation between successive heart beats. In general, high heart rate variability is linked to general good health, high cardiovascular fitness and resilience to stress. It can vary greatly from person to person, ranging from 20 to 150. It's best to compare your last night's value to your usual level.

Breathing rate shows your average breathing rate during roughly the first four hours of sleep. It is calculated from your beat-to-beat interval data. Your beat-to-beat intervals shorten when you breathe in and lengthen when you breathe out. During sleep, breathing rate slows down and varies mainly along with sleep stages. Typical values for a healthy adult at rest range from 12 to 20 breaths per minute. Higher values than usual may indicate a fever or impending illness.

Sleep charge details in Polar Flow

For sleep charge information in the Polar Flow app, see "Sleep data in the Flow app and web service" on page 47.

Personalized tips in the Flow app

Based on what we've measured from you, you get personalized daily tips in the Polar Flow app on exercise, and tips on sleep and regulating your energy levels on those particularly rough days. Tips for the day are displayed on the opening view of Nightly Recharge in the Flow app.

For exercise

You get an exercise tip every day. It tells you if you should take it easy or go for it. The tips are based on:

- Nightly Recharge status
- ANS charge
- Sleep charge
- Cardio load status

For more detailed workout suggestions, check out the [FitSpark™ daily training guide!](#)

For sleep

If you didn't sleep as well as usual, you get a sleep tip. It tells you how to improve the aspects of your sleep that weren't as good as usual. Besides parameters we measure from your sleep, we take into account:

- sleep rhythm over a longer period of time
- Cardio load status
- exercise on the previous day

For regulating energy levels

If your ANS charge status or sleep charge is particularly low, you get a tip that helps you get through the days with a lower recharge. They are practical tips on how to calm down when you're in overdrive, and how to energize when you need a boost.

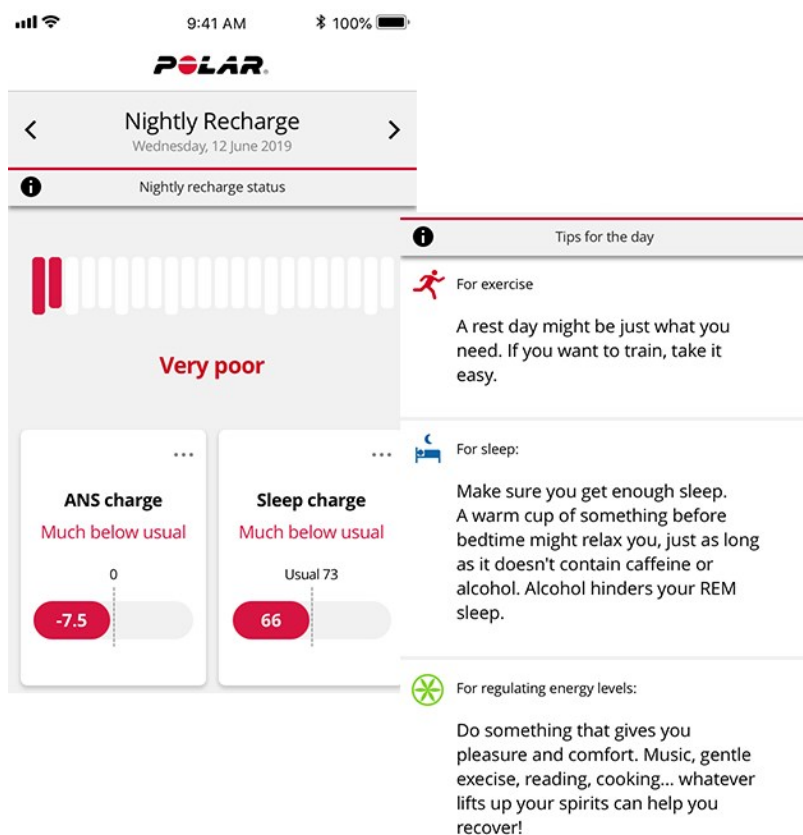

Learn more about the Nightly Recharge in this [in-depth guide](#).

SLEEP PLUS STAGES™ SLEEP TRACKING

Sleep Plus Stages automatically tracks the **amount** and **quality** of your sleep and shows you how long you spent in each **sleep stage**. It gathers your sleep time and sleep quality components into one easily glanceable value, **sleep score**. Sleep score tells you how well you slept compared to the indicators of a good night's sleep based on the current sleep science.

Comparing the components of the sleep score to your own usual level help you recognize which aspects of your daily routine may affect your sleep and may need adjusting. Nightly breakdowns of your sleep are available on your watch and in the Polar Flow app. Long-term sleep data in the Polar Flow web service helps you analyze your sleep patterns in detail.

How to start tracking your sleep with Polar Sleep Plus Stages™

1. The first thing you need to do is **set your preferred sleep time** in the Polar Flow or on your watch. In the Flow app, tap your profile, and choose **Your preferred sleep time**. Choose your preferred time and tap **Done**. Or sign into your Flow account or create a new one at flow.polar.com, and choose **Settings > Physical settings > Your preferred sleep time**. Set your preferred time and choose **Save**. Set your preferred sleep time on your watch from **Settings > Physical settings > Your preferred sleep time**.

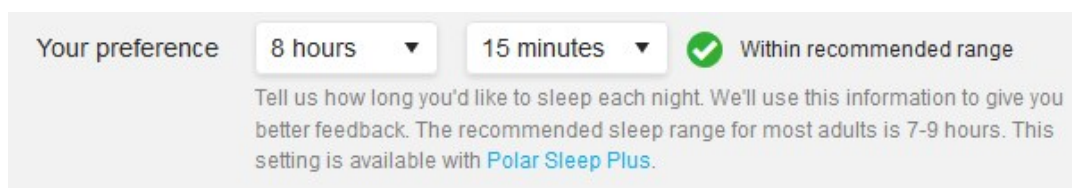

Sleep time preference is the amount of sleep you want to get each night. By default, it is set to the average recommendation for your age group (eight hours for adults from 18 to 64 years). If you feel that eight hours of sleep is too much or too little for you, we recommend you adjust your preferred sleep time to meet your individual needs. By doing this, you'll get accurate feedback on how much sleep you got in comparison to your preferred sleep time.

2. Continuous heart rate tracking needs to be enabled for Sleep Plus Stages to function. To enable Continuous HR tracking go to **Settings > General Settings > Continuous HR tracking** and select **On** or **Night-time only**. Tighten the wristband firmly around your wrist. The sensor on the back of the watch must be in constant touch with your skin. For more detailed wearing instructions, see [Wrist-based heart rate measurement](#).
3. Your watch detects when you fall asleep, when you wake up and how long you spent sleeping. The Sleep Plus Stages measurement is based on recording the movements of your non-dominant hand with a built-in 3D acceleration sensor and recording your heart's beat-to-beat interval data from your wrist with an optical heart rate sensor.
4. In the morning you can see your **sleep score** (1-100) from your watch. You get sleep stages information (light sleep, deep sleep, REM sleep) and a sleep score after one night, including feedback on sleep themes (amount, solidity and regeneration). After the third night, you get a comparison to your usual level.
5. You can record your own perception of your sleep quality in the morning by rating it on your watch or in the Flow app. Your own rating is not taken into account in the sleep charge calculation, but you can record your own perception and compare it to the sleep charge assessment you get.

Sleep data on your watch

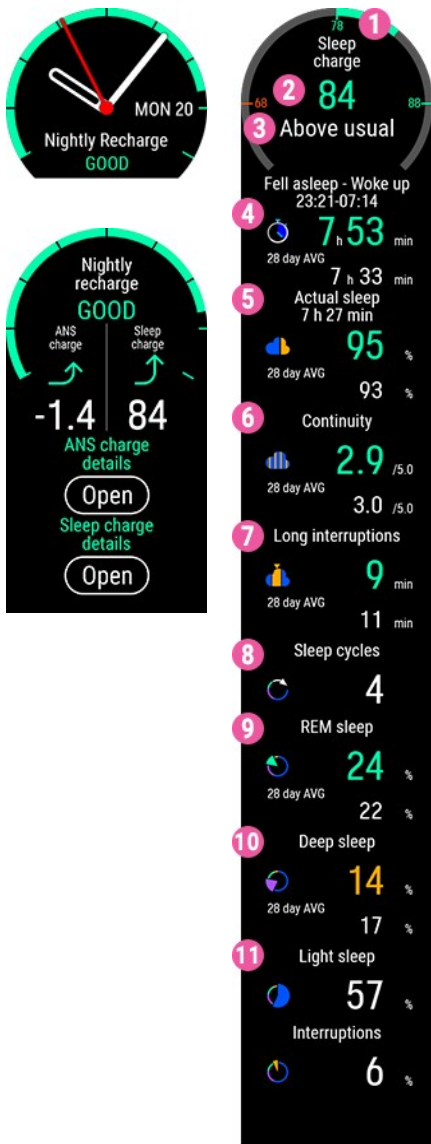

When you wake up you can access your sleep details via the [Nightly Recharge](#) watch face. Tap the display to open the Nightly recharge status details and then tap **Open** under **Sleep charge details**.

You can also stop the sleep tracking manually. **Already awake?** is shown on the sleep watch face when your watch has detected a minimum of four hours of sleep. Tap the **Already awake?** text to tell the watch that you're awake and it will ask you if you want to stop sleep tracking. Confirm by tapping and the watch summarizes your sleep instantly.

The sleep charge details view displays the following information:

1. **Sleep score status graph**
2. **Sleep score (1-100)** A score that summarizes your sleep time and sleep quality into a single number.
3. **Sleep charge** = Sleep score compared to your usual level. Scale: much below usual – below usual – usual – above usual – much above usual.
4. **Sleep time** tells you the total duration between when you fell asleep and when you woke up.
5. **Actual sleep (%)** tells the time spent asleep between the time you fell asleep and when you woke up. More specifically, it is your sleep time minus the interruptions. Only the time you actually spend asleep is included in actual sleep.
6. **Continuity (1-5)**: Sleep continuity is a rating of how continuous your sleep time was. Sleep continuity is evaluated on a scale from one to five: fragmented – fairly fragmented – fairly continuous – continuous – very continuous.
7. **Long interruptions (min)** tells the time you spent awake during the interruptions longer than one minute. During a normal night's sleep there are numerous short and long interruptions when you actually awakened from your sleep. Whether you remember these interruptions or not depends on their duration. The shorter ones we don't usually remember. The longer ones, for instance when one might get up for a sip of water, we can remember. Interruptions are illustrated as yellow bars on your sleep timeline.
8. **Sleep cycles**: A normal sleeper typically goes through 4-5 sleep cycles over the course of a night. This equals to a sleep time of approximately 8 hours.
9. **REM sleep %**: REM stands for rapid eye movement. REM sleep is also called paradoxical sleep as your brain is active but your muscles are inactive to avoid acting out dreams. Just as deep sleep restores your body, REM sleep restores your mind, and enhances memory and learning.
10. **Deep sleep %**: Deep sleep is the stage of sleep in which it is hard to be awakened since your body is less responsive to environmental stimuli. Most deep sleep occurs during the first half of the night. This sleep stage restores your body and supports your immune system. It also affects certain aspects of memory and learning. The stage of deep sleep is also called slow wave

sleep.

11. **Light sleep %:** Light sleep serves as a transition stage between wakefulness and the deeper stages of sleep. You can be easily awoken from light sleep since your responsiveness to the environmental stimuli remains quite high. Light sleep also promotes mental and physical recovery, although REM and deep sleep are the most important sleep stages in that regard.

Sleep data in the Flow app and web service

How you sleep is always individual — instead of comparing your sleep stats to others, follow your own long-term sleeping patterns to get a full understanding of how you sleep. Sync your watch with the Flow app after waking up to see your last night's sleep data in Polar Flow. Follow your sleep on a daily and weekly basis in the Flow app, and see how your sleeping habits and activity during the day affect your sleep.

Choose **Sleep** from the Flow app menu to see your sleep data. In the Sleep structure view you see how your sleep has progressed through different sleep stages (light sleep, deep sleep and REM sleep) and any interruptions to your sleep. Usually sleep cycles proceed from light sleep into deep sleep and then to REM sleep. Typically, a night's sleep consists of 4 to 5 sleep cycles. This equals to approximately 8 hours of sleep. During a normal night's sleep there are numerous short and long interruptions. The long interruptions are displayed with the tall orange bars in the sleep structure graph.

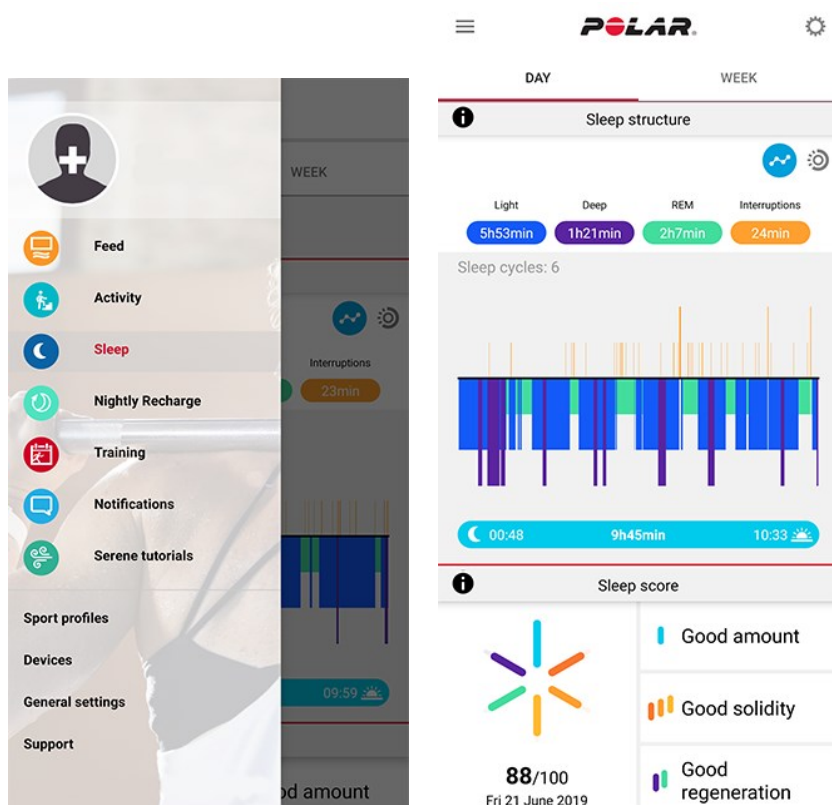

The six components of the sleep score are grouped under three themes: amount (sleep time), solidity (long interruptions, continuity and actual sleep) and regeneration (REM sleep and deep sleep). Each bar in the graph represents the score for each component. Sleep score is the average of these scores. By choosing the weekly view you can see how your sleep score and sleep quality (solidity and regeneration themes) vary during the week.

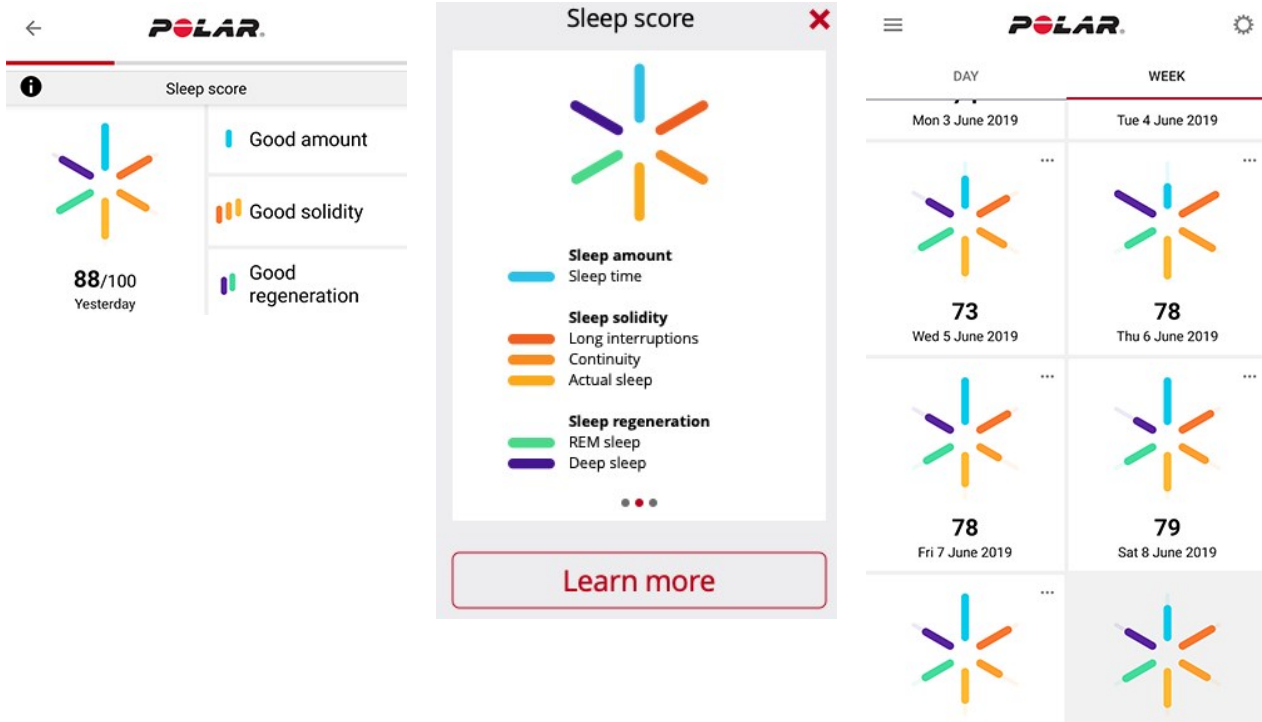

The Sleep rhythm section provides a weekly view of your sleep time and sleep stages.

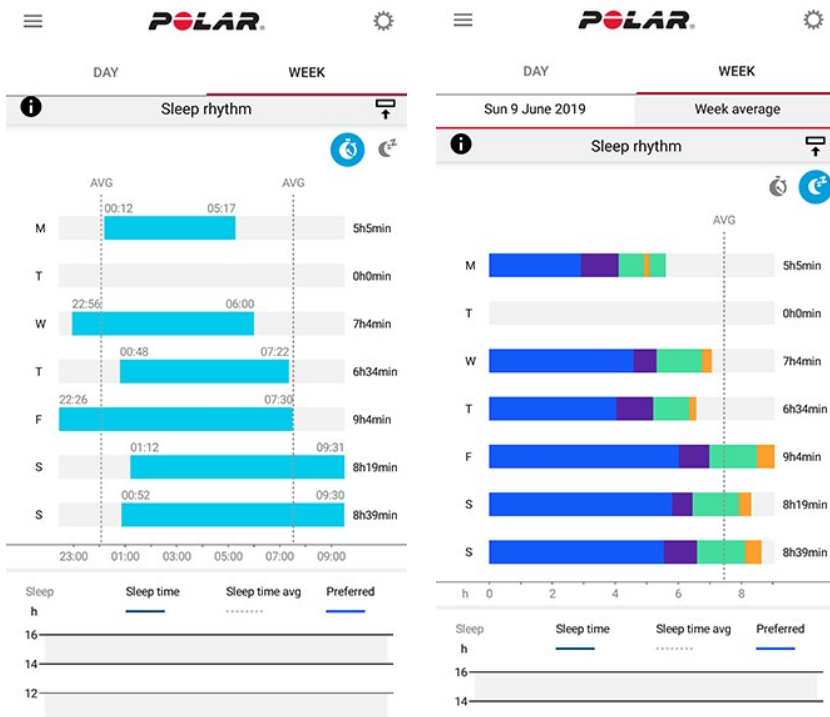

To view your long-term sleep data with sleep stages in the Flow web service go to **Progress**, and choose the **Sleep report** tab.

Sleep report gives you a long-term view to your sleep patterns. You can choose to view your sleep details for a 1-month, 3-month or 6-month period. You're able to see averages for the following sleep data: fell asleep, woke up, sleep time, REM sleep, deep sleep and interruptions to your sleep. You can view a nightly breakdown of your sleep data by hovering your mouse over the sleep graph.



Learn more about the Polar Sleep Plus Stages in this [in-depth guide](#).

FITSPARK™ DAILY TRAINING GUIDE

The FitSpark™ training guide offers ready-made **daily on-demand workouts** available easily right on your watch. The workouts are built to match your fitness level, training history and your recovery and readiness, based on your [Nightly Recharge](#) status from the previous night. FitSpark gives you 2-4 different workout options every day: one that suits you best and 1-3 other options to choose from. You get a maximum of four suggestions per day and there are 19 different workouts in total. Suggestions include workouts from the **cardio**, **strength** and **supportive** training categories.

FitSpark workouts are ready-made [training targets](#) defined by Polar. The workouts include instructions on how to perform the exercises and real-time step-by-step guidance to ensure you exercise safely and with proper technique. All workouts are time-based, and they are adjusted based on your current fitness level, making the sessions suitable for everyone, regardless of fitness level. The FitSpark workout suggestions are updated after each training session (including training sessions done without FitSpark), at midnight and when you wake up. FitSpark keeps your training versatile with different types of daily workouts to choose from.

How is your fitness level determined?

Your fitness level is determined for every workout suggestion based on your:

- Training history (average weekly heart rate zone realization from the previous 28 days)
- VO2max (from the [Fitness test](#) on your watch)
- [Training background](#)

You can start using the feature without any training history. However, FitSpark will work optimally after 7 days of use.



The higher the fitness level is, the longer the durations of the training targets are. The most demanding strength targets are not available at low fitness levels.

What type of exercises are included in the training categories?

In cardio sessions you're guided to train in different heart rate zones for different durations. Sessions include time-based warm-up, work and cool-down phases. Cardio sessions can be completed with any sport profile on your watch.

Strength sessions are circuit training type workouts consisting of strength training exercises with time-based guidance. Bodyweight workouts can be done using your own body as resistance - there is no need for additional weights. In circuit training workouts you need a bumper plate, a kettlebell or dumbbells to perform the exercises.

Supportive sessions are circuit training type workouts consisting of strength **and** mobility exercises with time-based guidance.

FitSpark on your watch

In time view, swipe left or right to navigate to the **FitSpark** watch face.

The **FitSpark** watch face includes the following views for different training categories:



PROGRAM WATCH FACE: If you have an active Running Program in Polar Flow your FitSpark suggestions are based on the Running Program training targets.

Tap the FitSpark watch face to see the most suitable workout for you based on your training history and fitness level. Tap the suggested workout to see detailed breakdown of the workout or tap **More** to see other optional workout suggestions. Swipe up to see the exercises included in the workout (strength and supportive workouts) and tap the individual exercise to see detailed instructions on how to perform the exercise. Tap **Start** to select the training target. Tap the sport profile to start the training target.

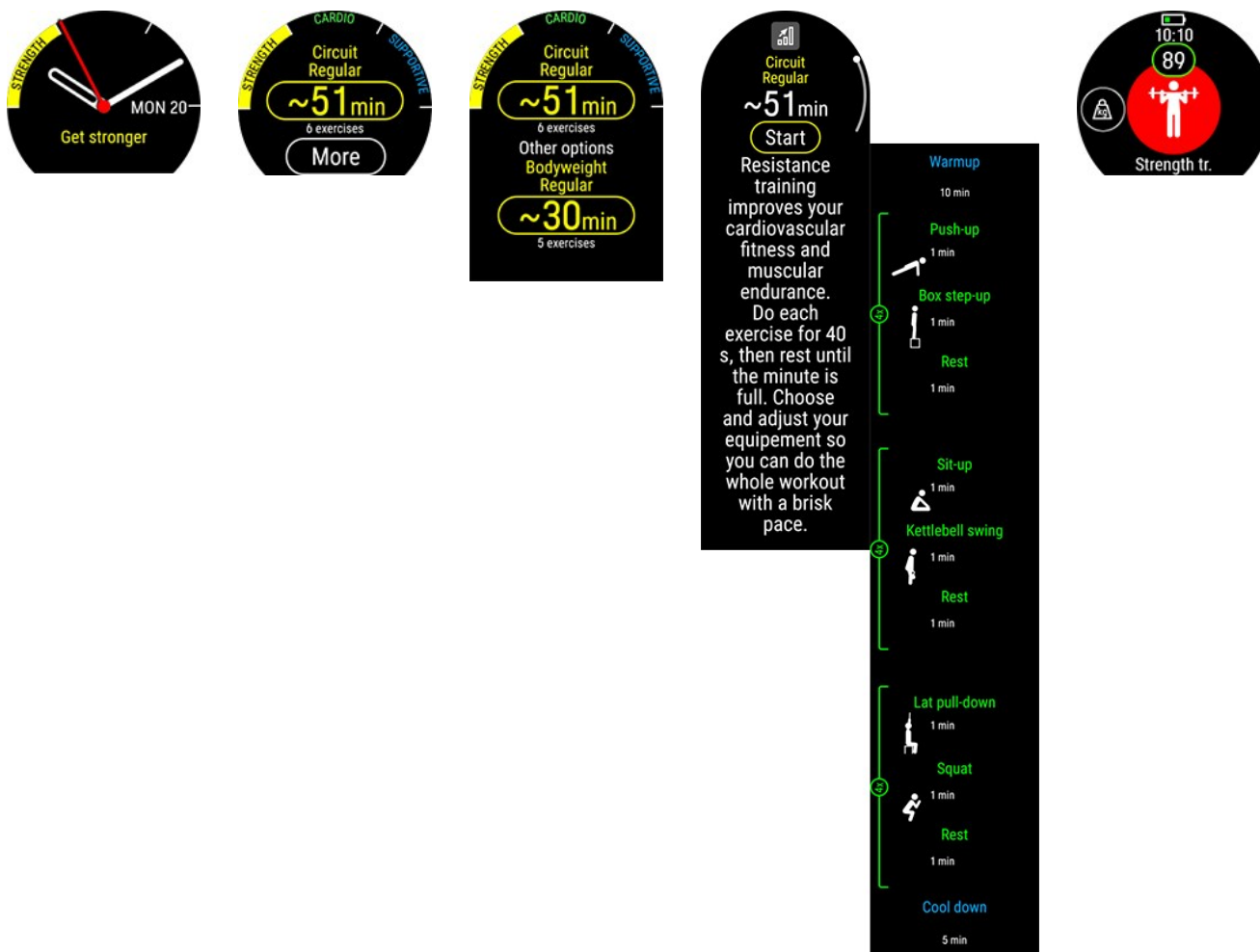

During training

Your watch gives you guidance during training, which includes training information, time-based phases with heart rate zones for cardio targets and time-based phases with exercises for strength and supportive targets.

Strength training and supportive training sessions are based on ready-made workout plans with exercise animations and real-time step-by-step guidance. All sessions include timers and vibrations that let you know when it's time to switch to the next phase. Continue each movement for 40 seconds, then rest until the minute is full and start the next movement. When you've completed all rounds of the first set, start the next set manually. You can end a training session any time you like. You cannot skip or re-arrange training phases.

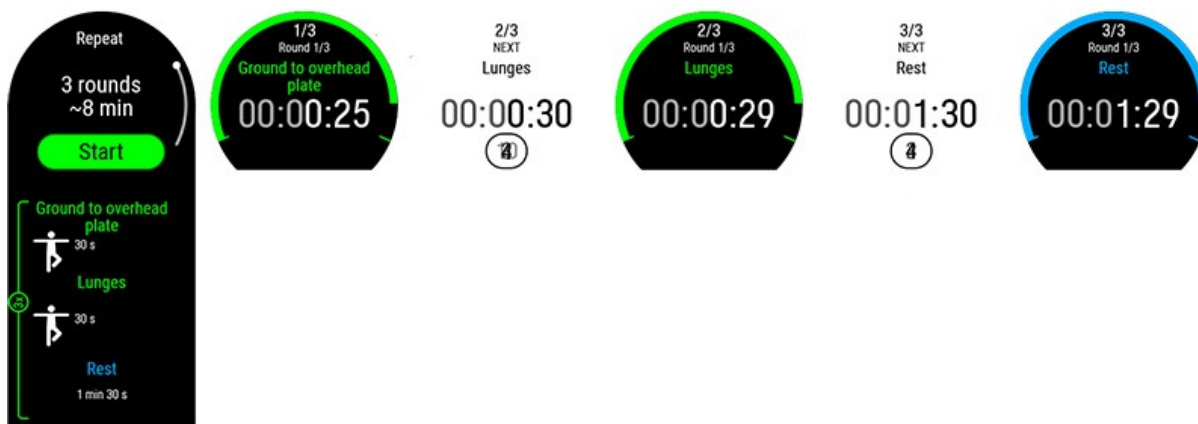

Backlight always on during training: Swipe down from the top of the display to pull down the [Quick settings](#) menu. Tap the Backlight icon to select **Always on** or **Automatic**. With always on the



watch display will be illuminated throughout your training session. The backlight setting will default back to automatic after you finish your training session. Please note that selecting always on will drain your battery much faster than the default setting.

Training results on your watch and in Polar Flow

You'll get a [summary](#) of your training session on your watch right after you've finished the session. You'll get a more detailed analysis in the Polar Flow app or in the Polar Flow web service. For cardio training targets you get a basic training result, which shows the phases of the session with heart rate data. For strength and supportive training targets you get detailed training results, which include your average heart rate and time spent on each exercise. These are displayed as a list, and each exercise is also displayed on the heart rate curve.

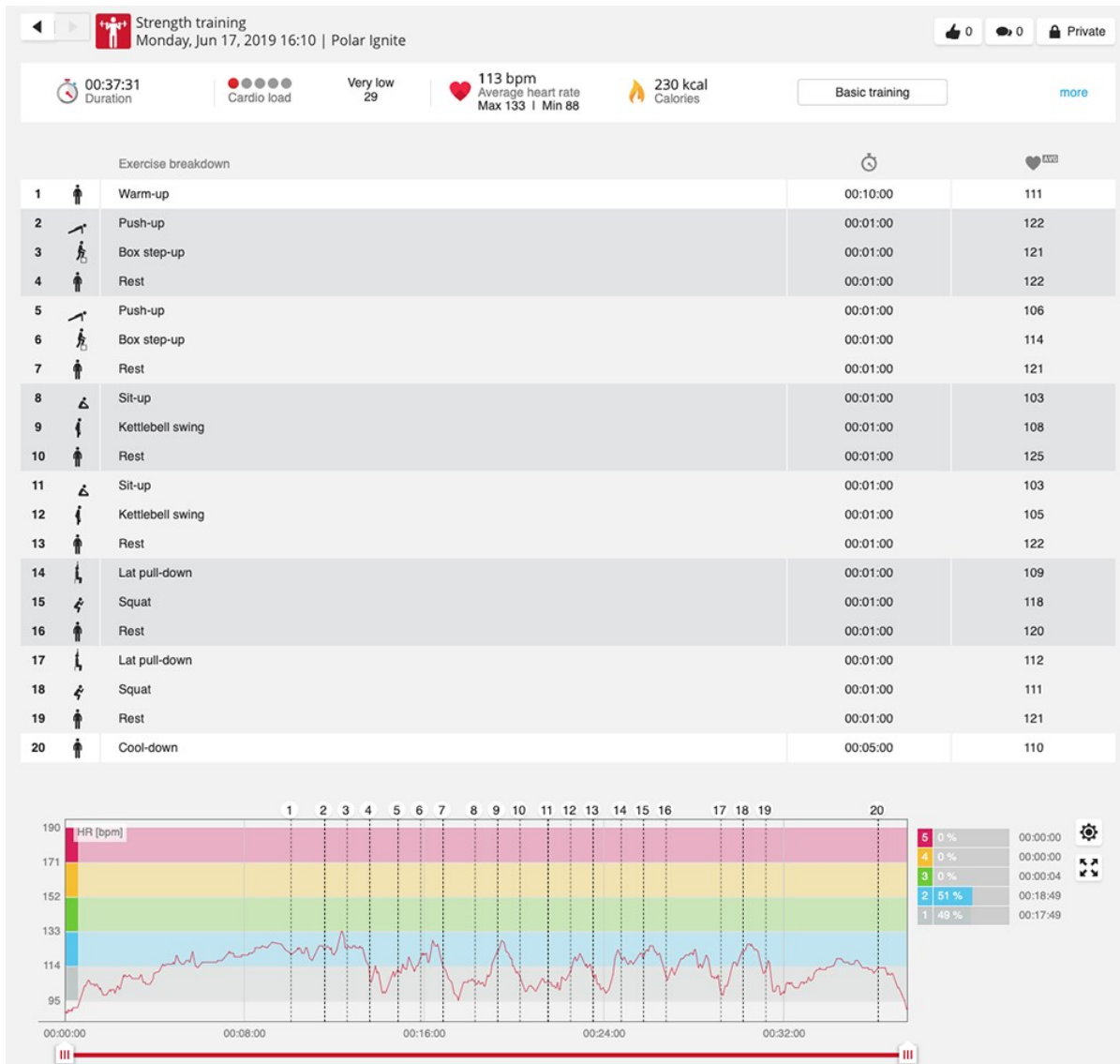

Training may include some risk. Before beginning a regular training program please read the [Minimizing risks when training](#) guidance.

SERENE™ GUIDED BREATHING EXERCISE

Serene™ is a **guided deep breathing exercise** that helps you relax your body and mind and manage stress. Serene guides you to breathe at a slow, regular rhythm – **six breaths per minute**, which is the optimal breathing rate for **stress-relieving effects**. When you breathe slowly, your heart beat starts to synchronize with the rhythm of your breathing and your heart's beat-to-beat intervals start to vary more.

During the breathing exercise your watch helps you maintain a regular slow breathing rhythm with an animation on the watch display and by vibrating. Serene measures your body's response to the exercise and gives you real-time biofeedback on how you're doing. After the exercise, you get a summary of the time you spent on the three **serenity zones**. The higher the zone, the better the synchronization with the optimal rhythm was. The more time you spend in the higher zones, the more benefits you can expect to feel in the long-term. When you use the Serene breathing exercise regularly, it can help you **manage stress**, improve the **quality of your sleep** and give you a sense of improved **overall well-being**.

Serene breathing exercise on your watch

The Serene breathing exercise guides you to **breathe deeply and slowly** to calm down the body and mind. When you breathe slowly, your heart beat starts to synchronize with the rhythm of your breathing. Your heart's beat-to-beat intervals vary more when your breathing is deeper and slower. Deep breathing produces measurable responses in the heart's beat-to-beat intervals. When you breath in, intervals between consecutive heart beats shorten (heart rate speeds up) and when you breath out, intervals between consecutive heart beats lengthen (heart rate slows down). The variance of your heart's beat-to-beat intervals is greatest when you are closest to the **6 breathing cycles per minute** rhythm (inhale + exhale = 10 seconds). This is the optimal rate for **stress-relieving effects**. This is why your success is measured not only from the synchronization, but also from how close you were to the optimal breathing rate.

The default duration of Serene breathing exercise is 3 minutes. You can adjust the duration of the breathing exercise in range between 2-20 minutes. You can also adjust inhale and exhale durations if needed. Fastest breathing frequency can be 3 seconds for inhale and 3 seconds for exhale resulting 10 breaths per minute. Slowest breathing frequency is 5 seconds for inhale and 7 seconds for exhale resulting 5 breaths per minute.

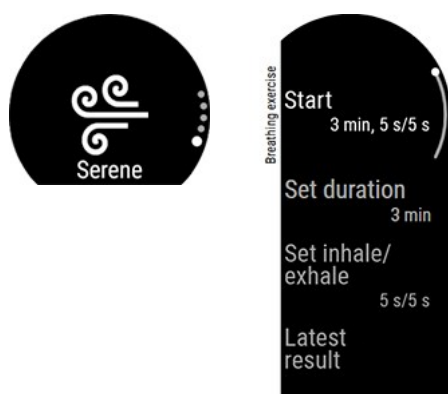

Check that your position allows you to keep your arms relaxed and your hands still throughout the entire breathing exercise. This allows you to relax properly and ensures that your Polar watch can accurately measure the effects of the session.

1. Wear your watch snugly just behind the wrist bone.
2. Sit or lie down comfortably.
3. Press the BACK button to enter the main menu and swipe up to find **Serene** breathing exercise.
4. First tap **Serene** and then tap **Start exercise** to start breathing exercise. Exercise starts with a 15 seconds preparatory phase.
5. Follow the breathing guidance on the display or through the vibration.
6. You can end the exercise by pressing BACK button at any time.
7. The main guiding element in the animation **changes color** according to which serenity zone you're currently in.
8. After the exercise, you'll see your results displayed on your watch as time spent in the different serenity zones.



The **serenity zones** are Amethyst, Sapphire and Diamond. The serenity zones tell you how well your heartbeat and breathing are in sync and how close you are to the optimal breathing rate of six breaths per minute. The higher the zone, the better the synchronization with the optimal rhythm. For the highest serenity zone, Diamond, you need to sustain a slow target rhythm of around six breaths per minute, or slower. The more time you spend in the higher zones, the more benefits you can expect to feel in the long-term.

Breathing exercise result

After the exercise, you get a summary of the time you spent on the three serenity zones.

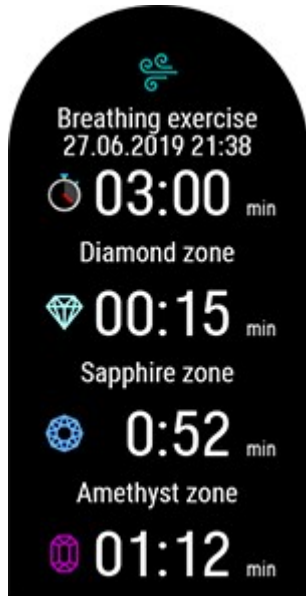

Learn more about the Serene™ guided breathing exercise in this [in-depth guide](#).

FITNESS TEST WITH WRIST-BASED HEART RATE

The Polar Fitness Test with wrist-based heart rate is an easy, safe and quick way to estimate your aerobic (cardiovascular) fitness at rest. The result, Polar OwnIndex, is comparable to maximal oxygen uptake (VO_{2max}), which is commonly used to evaluate aerobic fitness. Your long-term training background, heart rate, heart rate variability at rest, sex, age, height, and body weight all influence OwnIndex. The Polar Fitness Test is developed for use by healthy adults.

Aerobic fitness relates to how well your cardiovascular system works to transport oxygen to your body. The better your aerobic fitness, the stronger and more efficient your heart is. Good aerobic fitness has many health benefits. For example, it helps in decreasing the risk of high blood pressure and your risk of cardiovascular diseases and stroke. If you want to improve your aerobic fitness it takes, on average, six weeks of regular training to see a noticeable change in your OwnIndex. Less fit individuals see progress even more rapidly. The better your aerobic fitness, the smaller the improvements in your OwnIndex.

Aerobic fitness is best improved by training types that use large muscle groups. Such activities include running, cycling, walking, rowing, swimming, skating, and cross-country skiing. To monitor your progress, start by measuring your OwnIndex a couple of times during the first two weeks in order to get a baseline value, and then repeat the test approximately once a month.

To make sure the test results are reliable, the following basic requirements apply:

- You can perform the test anywhere - at home, at the office, at a health club - provided the testing environment is peaceful. There should be no disturbing noises (e.g. television, radio, or telephone) and no other people talking to

you.

- Always take the test in the same environment and at the same hour.
- Avoid eating a heavy meal or smoking 2-3 hours prior to testing.
- Avoid heavy physical exertion, alcohol, and pharmaceutical stimulants on the test day and the previous day.
- You should be relaxed and calm. Lie down and relax for 1-3 minutes before starting the test.

BEFORE THE TEST

Before starting the test, make sure your physical settings including training background are accurate in **Settings > Physical settings**.

Wear your watch snugly on top of your wrist, just behind the wrist bone. The heart rate sensor on the back of your watch must be in constant touch with your skin, but the wristband should not be too tight to prevent blood flow.

PERFORMING THE TEST

To perform the fitness test, press the BACK button and swipe up to find **Fitness Test**. First, tap **Fitness Test** and then on **Relax and start the test**.



- When heart rate is found, your current heart rate and **Lie down & relax** is shown on the display. Stay relaxed and limit body movements and communication with other people.
- You can interrupt the test in any phase by pressing BACK. **Test canceled** is shown.

If your watch cannot receive your heart rate signal, the message **Test failed** is shown. In which case, you should check that the heart rate sensor on the back of the watch is in constant touch with your skin. See [Wrist-based heart rate measurement](#) for detailed instructions on wearing your watch when measuring heart rate from your wrist.

TEST RESULTS

When the test is over, your watch notifies you by vibrating and shows a description of your fitness test result and your estimated VO_{2max} .

Update to VO_{2max} to physical settings? is shown.

- Tap  to save the value to your **Physical settings**.
- Tap  to cancel only if you know your recently measured VO_{2max} value, and if it differs more than one fitness level class from the result.

Your latest test result is shown in **Tests > Fitness test > Latest result**. Only your most recently performed test result is shown.

For a visual analysis of your Fitness test results, go to the Flow web service and select the test from your Diary to view details from it.



Your watch syncs with the Flow app automatically after the test if your phone is within the Bluetooth range.

Fitness level classes

Men

Age / Years	Very low	Low	Fair	Moderate	Good	Very good	Elite
20-24	< 32	32-37	38-43	44-50	51-56	57-62	> 62
25-29	< 31	31-35	36-42	43-48	49-53	54-59	> 59
30-34	< 29	29-34	35-40	41-45	46-51	52-56	> 56
35-39	< 28	28-32	33-38	39-43	44-48	49-54	> 54

Age / Years	Very low	Low	Fair	Moderate	Good	Very good	Elite
40-44	< 26	26-31	32-35	36-41	42-46	47-51	> 51
45-49	< 25	25-29	30-34	35-39	40-43	44-48	> 48
50-54	< 24	24-27	28-32	33-36	37-41	42-46	> 46
55-59	< 22	22-26	27-30	31-34	35-39	40-43	> 43
60-65	< 21	21-24	25-28	29-32	33-36	37-40	> 40

Women

Age / Years	Very low	Low	Fair	Moderate	Good	Very good	Elite
20-24	< 27	27-31	32-36	37-41	42-46	47-51	> 51
25-29	< 26	26-30	31-35	36-40	41-44	45-49	> 49
30-34	< 25	25-29	30-33	34-37	38-42	43-46	> 46
35-39	< 24	24-27	28-31	32-35	36-40	41-44	> 44
40-44	< 22	22-25	26-29	30-33	34-37	38-41	> 41
45-49	< 21	21-23	24-27	28-31	32-35	36-38	> 38
50-54	< 19	19-22	23-25	26-29	30-32	33-36	> 36
55-59	< 18	18-20	21-23	24-27	28-30	31-33	> 33
60-65	< 16	16-18	19-21	22-24	25-27	28-30	> 30

The classification is based on a literature review of 62 studies where VO_{2max} was measured directly in healthy adult subjects in the USA, Canada and 7 European countries. Reference: Shvartz E, Reibold RC. Aerobic fitness norms for males and females aged 6 to 75 years: a review. *Aviat Space Environ Med*; 61:3-11, 1990.

VO_{2MAX}

A clear link exists between maximal oxygen consumption (VO_{2max}) of the body and cardiorespiratory fitness because oxygen delivery to tissues is dependent on lung and heart function. VO_{2max} (maximal oxygen uptake, maximal aerobic power) is the maximal rate at which oxygen can be used by the body during maximal exercise; it is related directly to the maximal capacity of the heart to deliver blood to the muscles. VO_{2max} can be measured or predicted by fitness tests (e.g. maximal exercise tests, submaximal exercise tests, Polar Fitness Test). VO_{2max} is a good index of cardiorespiratory fitness and a good predictor of performance capability in endurance events such as distance running, cycling, cross-country skiing, and swimming.

VO_{2max} can be expressed either as milliliters per minute ($ml/min = ml \cdot min^{-1}$) or this value can be divided by the person's body weight in kilograms ($ml/kg/min = ml \cdot kg^{-1} \cdot min^{-1}$).

POLAR RUNNING PROGRAM

Polar Running program is a personalized program based on your fitness level, designed to make sure that you train right and avoid overreaching. It's intelligent, and adapts based on your development, and lets you know when it might be a good idea to cut back a little and when to step it up a notch. Each program is tailored for your event, taking your personal attributes, training background and preparation time into account. The program is free, and available in the Polar Flow web service at flow.polar.com.

Programs are available for 5k, 10k, half marathon and marathon events. Each program has three phases: Base building, Build-up and Tapering. These phases are designed to gradually develop your performance, and make sure you're ready on race day. Running training sessions are divided into five types: easy jog, medium run, long run, tempo run and interval. All sessions include warm-up, work, and cool-down phases for optimal results. In addition, you can choose to do strength, core, and mobility exercises to support your development. Each training week consists of two to five running sessions, and the total running training session duration per week varies from one to seven hours depending on your fitness level. The minimum duration for a program is 9 weeks, and the maximum is 20 months.

Learn more about the Polar Running Program in this [in-depth guide](#). Or read more about how to [get started with the Running Program](#).

To see a video, click on one of the following links:

[Get Started](#)

[How to use](#)

CREATE A POLAR RUNNING PROGRAM

1. Log into the Flow web service at flow.polar.com.
2. Choose **Programs** from the Tab.
3. Choose your event, name it, set the event date, and when you wish to start the program.
4. Fill in the physical activity level questions.*
5. Choose if you want to include supporting exercises in the program.
6. Read and fill in the physical activity readiness questionnaire.
7. Review your program, and adjust any settings if necessary.
8. When you're done, choose **Start program**.

*If four weeks of training history is available, these will be pre-filled.

START A RUNNING TARGET

Before starting a session, make sure you've synced your training session target to your device. The sessions are synced to your device as training targets.

To start a training target scheduled for the current day:

1. Enter the pre-training mode by pressing first the BACK button and then tapping **Start training**.
2. You'll be prompted to start a training target you've scheduled for the day.



3. Tap  to view the target information.
4. Press BACK to return to pre-training mode, and choose the sport profile you want to use.
5. When the watch has found all the signals, tap the display. **Recording started** is displayed and you can start training.

FOLLOW YOUR PROGRESS

Sync your training results from your device to the Flow web service via the FlowSync or the Flow app. Follow your progress from the **Programs** tab. You'll see an overview of your current program, and how you've progressed.

CARDIO LOAD

Cardio load is based on training impulse calculation (TRIMP), a commonly accepted and scientifically proven method to quantify training load. Your Cardio load value tells you how much strain your training session put on your cardiovascular system. The higher the Cardio load, the more strenuous the training session was for the cardiovascular system. Cardio load is calculated after every workout from your heart rate data and session duration.

Your cardio load from a single session is shown in the summary of your training session on your watch, in the Flow app and in the Flow web service. The higher the cardio load, the more strain it caused to your body. In addition, you can see a visual bullet scale interpretation and a verbal description of how hard your cardio load from the session was compared to your 90 days cardio load average.

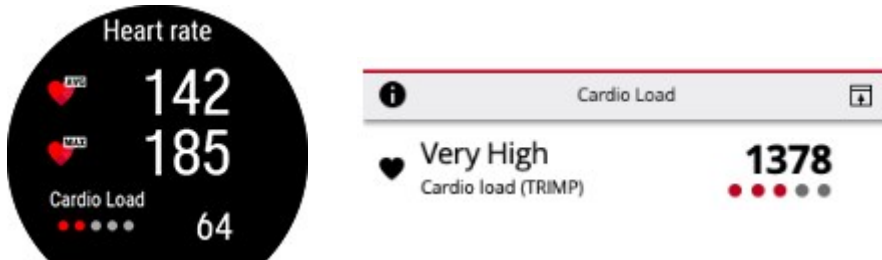

The scale of bullets and verbal descriptions adapts according to your progress: the smarter you train, the higher loads you tolerate. As your fitness and tolerance for training improves, a cardio load that was ranked worth 3 bullets (Medium) a couple of months ago, could rank for only 2 bullets (Low) later on. This adaptive scale reflects the fact that the same kind of training session can have a different impact on your body depending on your current condition.

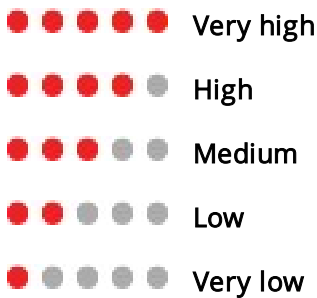

TRAINING BENEFIT

Training Benefit gives you textual feedback on the effect of each training session helping you to better understand the effectiveness of your training. **You can see the feedback in Flow app and Flow web service.** To get the feedback, you need to have trained at least a total of 10 minutes in the [heart rate zones](#).

Training Benefit feedback is based on heart rate zones. It reads into how much time you spend and how many calories you burn in each zone.

The descriptions of different training benefit options are listed in the table below

Feedback	Benefit
Maximum training+	What a session! You improved your sprint speed and the nervous system of your muscles, which make you more efficient. This session also increased your resistance to fatigue.
Maximum training	What a session! You improved your sprint speed and the nervous system of your muscles, which make you more efficient.
Maximum & Tempo training	What a session! You improved your speed and efficiency. This session also significantly developed your aerobic fitness and your ability to sustain high intensity effort for longer.

Feedback	Benefit
Tempo & Maximum training	What a session! You significantly improved your aerobic fitness and your ability to sustain high intensity effort for longer. This session also developed your speed and efficiency.
Tempo training+	Great pace in a long session! You improved your aerobic fitness, speed, and ability to sustain high intensity effort for longer. This session also increased your resistance to fatigue.
Tempo training	Great pace! You improved your aerobic fitness, speed, and ability to sustain high intensity effort for longer.
Tempo & Steady state training	Good pace! You improved your ability to sustain high intensity effort for longer. This session also developed your aerobic fitness and the endurance of your muscles.
Steady state & Tempo training	Good pace! You improved your aerobic fitness and the endurance of your muscles. This session also developed your ability to sustain high intensity effort for longer.
Steady state training +	Excellent! This long session improved the endurance of your muscles and your aerobic fitness. It also increased your resistance to fatigue.
Steady state training	Excellent! You improved the endurance of your muscles and your aerobic fitness.
Steady state & Basic training, long	Excellent! This long session improved the endurance of your muscles and your aerobic fitness. It also developed your basic endurance and your body's ability to burn fat during exercise.
Steady state & Basic training	Excellent! You improved the endurance of your muscles and your aerobic fitness. This session also developed your basic endurance and your body's ability to burn fat during exercise.
Basic & Steady state training, long	Great! This long session improved your basic endurance and your body's ability to burn fat during exercise. It also developed the endurance of your muscles and your aerobic fitness.
Basic & Steady state training	Great! You improved your basic endurance and your body's ability to burn fat during exercise. This session also developed the endurance of your muscles and your aerobic fitness.
Basic training, long	Great! This long, low intensity session improved your basic endurance and your body's ability to burn fat during exercise.
Basic training	Well done! This low intensity session improved your basic endurance and your body's ability to burn fat during exercise.
Recovery training	Very nice session for your recovery. Light exercise like this allows your body to adapt to your training.

SMART CALORIES

The most accurate calorie counter on the market calculates the number of calories burned based on your individual data:

- Body weight, height, age, gender
- Individual maximum heart rate (HR_{max})
- The intensity of your training or activity
- Individual maximal oxygen uptake ($VO2_{max}$)

The calorie calculation is based on an intelligent combination of acceleration and heart rate data. The calorie calculation measures your training calories accurately.

You can see your cumulative energy expenditure (in kilocalories, kcal) during training sessions, and your total kilocalories of the session afterwards. You can also follow your total daily calories.

CONTINUOUS HEART RATE

The Continuous heart rate feature measures your heart rate around the clock. It enables a more accurate measurement of daily calorie consumption and your overall activity because also physical activities with very little wrist movement, such as cycling, can now be tracked.

Continuous heart rate on your watch

You can turn the Continuous heart rate feature on, off or to night-time only mode on your watch in **Settings > General settings > Continuous HR tracking**.



The feature is on by default in Polar Unite. Using the night-time only mode will extend the battery life.

In time view, swipe left or right to navigate to the heart rate watch face. Tap the display to open detailed view.



When the feature is on, the watch continuously measures your heart rate and displays it on the Heart rate watch face. When opening the details, you can check your highest and lowest heart rate readings of the day and also view what your lowest heart rate reading of the previous night was.

The watch tracks your heart rate in 5-minute intervals and records the data for later analysis in the Flow app or web service. If the watch detects that your heart rate is elevated, it starts to record your heart rate continuously. Continuous recording can also start based on your wrist movements, for example, when you're walking with a fast enough pace for at least one minute. The continuous recording of your heart rate stops automatically when your activity level drops low enough. When your watch detects that your arm is not moving or when your heart rate is not elevated it tracks your heart rate in 5-minute cycles to find your lowest reading of the day.

In some cases, it is possible that you've seen a higher or lower heart rate on your watch during the day than is shown in the continuous heart rate summary as the highest or lowest reading of your day. This can happen if the reading you've seen falls outside the tracking interval.



The LEDs on the back of your watch are always on when the continuous heart rate feature is on and the sensor on the back is in touch with your skin. For instructions on how to wear your watch for accurate heart rate readings from the wrist, see [Wrist-based heart rate measurement](#).

You can follow the Continuous Heart Rate data in more detail and in longer periods in Polar Flow, either in web or in the mobile app. Learn more about the Continuous Heart Rate feature in this [in-depth guide](#).

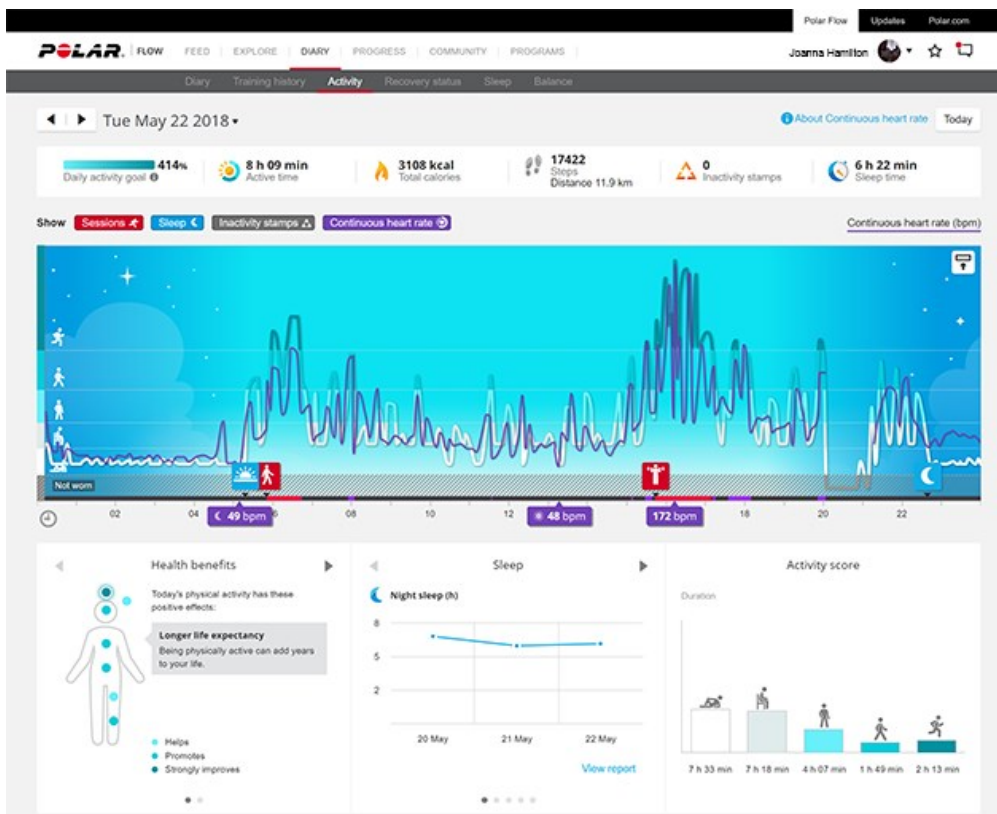

24/7 ACTIVITY TRACKING

The Polar Unite tracks your activity with an internal 3D accelerometer that records your wrist movements. It analyzes the frequency, intensity and regularity of your movements together with your physical information, allowing you to see how active you really are in your everyday life, on top of your regular training. You should wear your watch on your non-dominant hand to ensure you get the most accurate activity tracking.

ACTIVITY GOAL

You'll get your personal activity goal when you set up your watch. The activity goal is based on your personal data and activity level setting, which you can find on your watch (**Settings > Physical settings > Activity goal**), in the Polar Flow app or in the [Polar Flow web service](https://flow.polar.com).

If you want to change your goal, open your Flow app, tap your name/profile photo in the menu view, and swipe down to see **Activity goal**. Or go to flow.polar.com and sign in to your Polar account. Then click your name > **Settings > Activity goal**. Choose one of the three activity levels that best describes your typical day and activity. Below the selection area, you can see how active you need to be to reach your daily activity goal on the chosen level.

The time you need to be active during the day to reach your activity goal depends on the level you have chosen and the intensity of your activities. Meet your goal faster with more intense activities or stay active at a slightly more moderate pace throughout the day. Age and gender also affect the intensity you need to reach your activity goal. The younger you are, the more intense your activity needs to be.

ACTIVITY DATA ON YOUR WATCH

In time view, swipe left or right to navigate to the Activity watch face.



The circle around the watch face and the percentage below time and date show your progress towards your daily activity goal. The circle fills with light blue color as you are active.

In addition, you can see the following details of your day's accumulated activity:



- Steps you've taken so far. The amount and type of body movements are registered and turned into an estimation of steps.
- Active time tells you the cumulative time of body movements that benefit your health.
- Calories you've burned through training, activity and BMR (Basal metabolic rate: the minimum metabolic activity required to maintain life).

Inactivity alert

It's widely known that physical activity is a major factor in maintaining health. In addition to being physically active, it's important to avoid prolonged sitting. Sitting for long periods of time is bad for your health, even on those days when you train and gain enough daily activity. Your Polar Unite spots if you're being inactive for too long during your day and this way helps you to break up your sitting to avoid the negative effects it has on your health.

If you've been still for 55 minutes, you'll get an inactivity alert: **It's time to move** is shown along with a small vibration. Stand up and find your own way to be active. Take a short walk, stretch, or do some other light activity. The message goes away when you start moving or press the BACK button. If you don't get active in five minutes, you'll get an inactivity stamp, which you can see on the Flow app and Flow web service after syncing. The Flow app and Flow web service show you the whole history of how many inactivity stamps you have received. This way you can check back on your daily routine and make changes towards a more active life.

ACTIVITY DATA IN THE FLOW APP AND WEB SERVICE

With the Flow app you can follow and analyze your activity data on the go and sync it wirelessly from your watch to the Flow web service. The Flow web service gives you the most detailed insight into your activity information. With the help of the activity reports (under the **REPORTS** tab), you can follow the long-term trend of your daily activity. You can choose to view either daily, weekly or monthly reports.

Learn more about the 24/7 Activity tracking feature in this [in-depth guide](#).

ACTIVITY BENEFIT

Activity benefit gives you feedback on the health benefits that being active has given you, and also on what kind of unwanted effects sitting for too long has caused to your health. The feedback is based on international guidelines and research on the health effects of physical activity and sitting behavior. The core idea is: the more active you are, the more benefits you get!

Both the Flow app and Flow web service show the activity benefit of your daily activity. You can view the activity benefit on daily, weekly and monthly basis. In the Flow web service, you can also view the detailed information on health benefits.

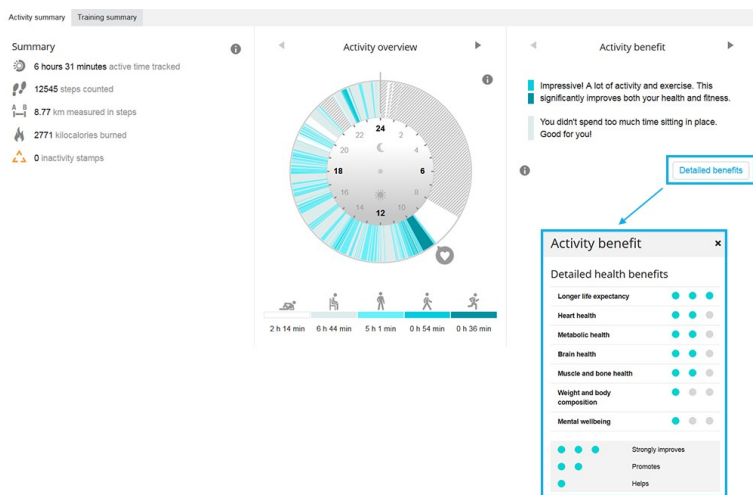

For more information, see [24/7 Activity Tracking](#).

SPORT PROFILES

Sport profiles are the sport choices you have on your watch. We have created 12 default sport profiles to your watch, but you can add new sport profiles in the Polar Flow app or web service and sync them to your watch, and this way create a list of all your favorite sports.

You can also define specific settings for each sport profile. For example, you can create tailored **training views** for each sport you do and choose what data you want to see when you train: just your heart rate or just speed and distance—whatever suits you and your training needs and requirements best.

You can have a maximum of 20 sport profiles on your watch at a time. The number of sport profiles in Polar Flow mobile app and Polar Flow web service is not limited.

For more information, see [Sport Profiles in Flow](#).

Using the sport profiles makes it possible for you to keep up with what you've done and to see the progress you've made in different sports. See your training history and follow your progress in the [Flow web service](#).



You can use Polar Unite with [Polar Club](#) during group exercise classes in fitness clubs. Select one of the indoor sport profiles for the training session and make sure that the Heart rate visible to other device feature is set on in the [sport profile settings](#).



Please note that in a number of indoor sports, group sports and team sports profiles the **HR visible to other devices** setting is enabled by default. This means that compatible devices using Bluetooth Smart wireless technology, e.g. gym equipment, can detect your heart rate. You can check which sport profiles have Bluetooth broadcasting enabled by default from the [Polar Sport profiles list](#). You can enable or disable Bluetooth broadcasting from [sport profile settings](#).

HEART RATE ZONES

The range between 50% and 100% of your maximum heart rate is divided into five heart rate zones. By keeping your heart rate within a certain heart rate zone you can easily control the intensity level of your workout. Each heart rate zone carries its own main benefits, and understanding these benefits will help you achieve the effect you want from your workout.

Learn more about the Heart Rate Zones: [What are Heart Rate Zones?](#)

SPEED ZONES

With the speed/pace zones you can easily monitor speed or pace during your session, and adjust your speed/pace to achieve the targeted training effect. The zones can be used to guide the efficiency of your training during sessions, and help you mix up your training with different training intensities for optimal effects.

SPEED ZONES SETTINGS

The speed zone settings can be adjusted in the Flow web service. There are five different zones, and zone limits can be manually adjusted or you can use the default ones. They are sport specific, allowing you to adjust the zones to best suit each sport. The zones are available in running sports (including team sports that involve running), cycling sports as well as rowing and canoeing.

Default

If you choose **Default**, you cannot change the limits. The default zones are an example of speed/pace zones for a person with a relatively high fitness level.

Free

If you choose **Free**, all limits can be changed. For example, if you have tested your actual thresholds, such as anaerobic and aerobic thresholds, or upper and lower lactate thresholds, you can train with zones based on your individual threshold speed or pace. We recommend that you set your anaerobic threshold speed and pace as the minimum for zone 5. If you also use aerobic threshold, set that as the minimum of zone 3.

TRAINING TARGET WITH SPEED ZONES

You can create training targets based on speed/pace zones. After synchronizing the targets via FlowSync, you'll receive guidance from your training device during training.

DURING TRAINING

During your training you can view which zone you are currently training in and the time spent in each zone.

AFTER TRAINING

In the training summary on your watch, you'll see an overview of the time spent in each speed zone. After syncing, detailed visual speed zone information can be viewed in the Flow web service.

SPEED AND DISTANCE FROM THE WRIST

Your watch measures speed and distance from your wrist movements with a built-in accelerometer. This feature comes in handy when running indoors or in places with limited GPS signals. For maximum accuracy make sure you've set your handedness and height correctly. Speed and distance from the wrist works best when running at a pace that is natural and feels comfortable for you.

Wear your watch snugly on your wrist to avoid any shaking. To get consistent readings it should always be worn on the same position on your wrist. Avoid wearing any other devices like watches, activity trackers or phone armbands on the same arm. In addition, do not hold anything in the same hand like a map or a phone.

Speed and distance from the wrist is available in the following running type sports: Walking, Running, Jogging, Road running, Trail running, Treadmill running, Track and field running and Ultra running. To see speed and distance during a training session, make sure you have speed and distance added to the training view of the sport profile you use when running. This can be done in **Sport Profiles** in the Polar Flow mobile app or in the Flow web service.

PHONE NOTIFICATIONS

The phone notifications feature allows you to get alerts about incoming calls, messages and notifications from apps onto your watch. You'll get the same notifications on your watch that you get on your phone screen. Phone notifications are

available for iOS and Android phones.

To use phone notifications, you need to have the Flow app running on your phone, and it also needs to be paired with your watch. For instructions, see [Pairing a mobile device with your watch](#)

SET PHONE NOTIFICATIONS ON

On your watch go to **Settings > General settings > Phone notifications** to set them on. Set phone notifications **Off** or **On, when not training**. Note that you will not receive any notifications during training sessions.

In Flow app go to the **Devices** menu, choose your device and make sure **Smart notifications/Phone notifications** are **On**.

After setting the notifications on sync your watch with the Flow app.



Please note that when phone notifications are set on the battery of your watch and phone will run out faster because Bluetooth is continuously on.

DO NOT DISTURB

If you want to disable notifications and call alerts for a certain period of time, set do not disturb on. When it is on, you will not receive any notifications or call alerts during the time period you have set.

On your watch go to **Settings > General settings > Do not disturb**. Choose **Off, On** or **On (22.00 - 7.00)**, and the period when do not disturb is on. Choose when it **Starts at** and **Ends at**.

VIEW NOTIFICATIONS

Whenever you receive a notification your watch will vibrate and a red dot will appear at the bottom of the display. View the notification by swiping up from the bottom of the display or by turning your wrist to look at the watch immediately after the watch vibrates.

When receiving a call your watch will vibrate and show the caller. You can also answer or decline the call with your watch.



Phone notifications may function differently depending on the model of your Android phone.

CHANGEABLE WRISTBANDS

The changeable wristbands let you personalize your watch to match every situation and style so you can wear it all the time and make the best use of the 24/7 activity tracking, continuous heart rate measurement and sleep tracking.

The Polar Unite is compatible with all 20 mm wristbands. You can choose your favorite wristband from Polar's selection or use any other wristband that uses 20 mm spring bars. Make sure that the wristband width is the correct, before you purchase the new wristband.

CHANGING THE WRISTBAND

The wristband of your watch is quick and simple to change.

1. To detach a band, pull the quick-release knob inwards and pull the band away from the watch.
2. To attach a band, insert the pin (the opposite side of the quick-release knob) into the pin hole on the watch.
3. Pull the quick-release knob inwards and align the other end of the pin with the hole on the watch.
4. Release the knob to lock the band in place.

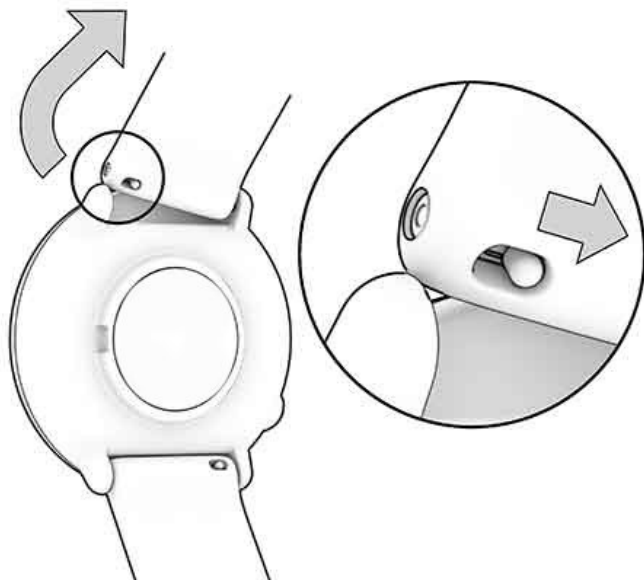

COMPATIBLE SENSORS

Enhance your training experience, and achieve a more complete understanding of your performance with compatible Bluetooth® sensors.

[View a full list of compatible Polar sensors and accessories](#)

Before taking a new sensor into use, it has to be paired with your watch. Pairing only takes a few seconds, and ensures that your watch receives signals from your sensors only, and allows disturbance-free training in a group. Before entering an event or race, make sure that you do the pairing at home to prevent interference due to data transmission. For instructions, see [Pairing sensors with your watch](#).

POLAR H10 HEART RATE SENSOR

Monitor your heart rate with maximum precision with the Polar H10 heart rate sensor with a chest strap.

Although the Polar Precision Prime is the most accurate optical heart rate measurement technology there is and works pretty much anywhere, in sports where it's more challenging to keep the sensor stationary on your wrist or where you have pressure or movement in muscles or tendons near the sensor, the Polar 10 heart rate sensor gives you the best heart rate accuracy. The Polar H10 heart rate sensor is more responsive to rapidly increasing or decreasing heart rate, so it's the ideal option also for interval type of training with quick sprints.

The Polar H10 heart rate sensor has an internal memory that allows you to record one training session with it without a connected training device or a mobile training app close by. You just need to pair the H10 heart rate sensor with the Polar Beat app and start the training session with the app. This way, you can for example record your heart rate from your swimming sessions with the Polar H10 heart rate sensor. For more information see the support pages for [Polar Beat](#) and [Polar H10 heart rate sensor](#).

When using the Polar H10 heart rate sensor during your cycling sessions, you can have your watch mounted to your bike's handlebars to easily view your training data while riding.

POLAR H9 HEART RATE SENSOR

Polar H9 is a high quality heart rate sensor for your everyday sports. It comes with the Polar Soft Strap and tracks your heart rate accurately. Polar H9 is ideal with the Polar Beat app as well as many 3rd party apps: you can turn your phone into a fitness tracker easily. Further, Bluetooth®, ANT+™ and 5 kHz technologies ensure connections to a large variety of sports devices and gym equipment. Thanks to chest strap measurement Polar H9 reacts instantaneously to what happens in your body and gives you accurate calorie burn.

The latest version of this user manual and video tutorials can be found at support.polar.com/en/h9-heart-rate-sensor.

PAIRING SENSORS WITH YOUR WATCH

PAIR A HEART RATE SENSOR WITH YOUR WATCH



When you're wearing a Polar heart rate sensor that's paired with your watch, the watch does not measure heart rate from the wrist.

1. Moisten the electrode areas of the strap.
2. Attach the connector to the strap.
3. Fasten the strap around your chest and adjust the strap to fit snugly.
4. On your watch, go to **Settings > General Settings > Pair and sync** and Tap **Pair sensor or other device**.
5. Touch your heart rate sensor with your watch and wait for it to be found.
6. Once the heart rate sensor is found, the device ID, for example, **Polar H10 xxxxxxxx** is displayed. Tap  to start pairing.
7. **Pairing done** is displayed when you are done.

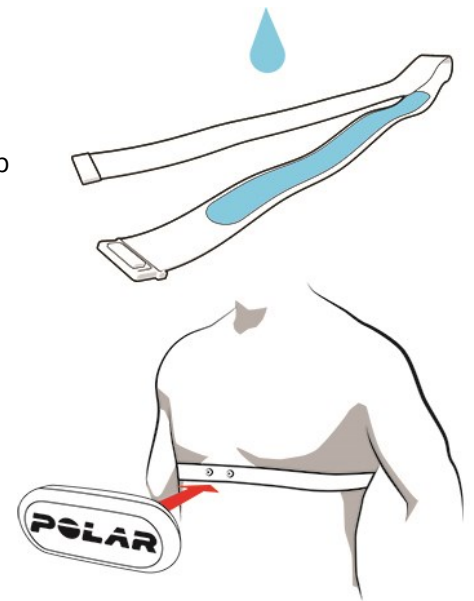

POLAR FLOW

POLAR FLOW APP

In the Polar Flow mobile app, you can see an instant visual interpretation of your training and activity data. You can also plan your training in the app.

TRAINING DATA

With the Polar Flow app, you can easily access the information of your past and planned training sessions and create new training targets. You can choose to create a quick target or a phased target.

Get a quick overview of your training, and analyze every detail of your performance right away. See weekly summaries of your training in the training diary. You can also share the highlights of your training with your friends with the [Image sharing](#) function.

ACTIVITY DATA

See details of your 24/7 activity. Find out how much you're missing from your daily activity goal and how to reach it. See steps, covered distance based on steps and burned calories.

SLEEP DATA

Follow your sleeping patterns to see if they're affected by any changes in your daily life and find the right balance between rest, daily activity and training. With the Polar Flow app, you can view the timing, amount, and quality of your sleep.

You can set your preferred sleep time to define how long you aim to sleep every night. You can also rate your sleep. You'll receive feedback on how you slept based on your sleep data, your preferred sleep time and your sleep rating.

SPORT PROFILES

You can add, edit, remove and reorganize sport profiles easily in the Flow app. You can have up to 20 sport profiles active in Flow app and in your watch.

For more information, see [Sport profiles in Polar Flow](#).

IMAGE SHARING

With Flow app's image sharing function you can share images with your training data on them to most common social media channels, like Facebook and Instagram. You can either share an existing photo or take a new one and customize it with your training data. If you had GPS recording on during your training session, you can also share a snapshot of your training route.

To see a video, click on the following link:

[Polar Flow app | Sharing training results with a photo](#)

START USING THE FLOW APP

You can [set up your watch](#) using a mobile device and the Flow app.

To start using the Flow app, download it from the App Store or Google Play onto your mobile device. For support and more information about using the Polar Flow app, go to support.polar.com/en/support/Flow_app.

Before taking a new mobile device (smartphone, tablet) into use, it has to be paired with your watch. See [Pairing](#) for more details.

Your watch syncs your training data to the Flow app automatically after your session. If your phone has an internet connection, your activity and training data are also synced automatically to the Flow web service. Using the Flow app is the easiest way to sync your training data from your watch with the web service. For information on syncing, see [Syncing](#).

For more information and instructions on Flow app features, visit [Polar Flow app product support page](#).

POLAR FLOW WEB SERVICE

In the Polar Flow web service, you can plan and analyze your training in detail and learn more about your performance. Set up and customize your watch to perfectly fit your training needs by adding sport profiles and editing their settings. You can also share the highlights of your training with your friends in the Flow community, sign up for your club's classes and get a personalized training program for a running event.

The Polar Flow web service also shows your daily activity goal completion percentage and the details of your activity, and helps you understand how your daily habits and choices affect your well-being.

You can [set up your watch](#) with your computer at flow.polar.com/start. There you are guided to download and install the FlowSync software for syncing data between your watch and the web service, and to create a user account for the web service. If you did the setup using a mobile device and the Flow app, you can log into the Flow web service with the credentials you created in the setup.

FEED

In **Feed** you can see what you and your friends have been up to lately. Check out the latest training sessions and activity summaries, share your best achievements, comment and like your friends' activities.

DIARY

In **Diary** you can see your daily activity, sleep, planned training sessions (training targets), as well as review past training results.

REPORTS

In **Reports** you can follow your development.

Training reports are a handy way to follow your progress in training over longer periods. In week, month and year reports you can choose the sport for the report. In custom period, you can choose both the period and the sport. Choose the time period and sport for report from the drop-down lists, and press the wheel icon to choose what data you want to view in the report graph.

With the help of the activity reports, you can follow the long-term trend of your daily activity. You can choose to view either daily, weekly or monthly reports. In the activity report you can also see your best days regarding daily activity, steps, calories and sleep from your chosen time period.

COMMUNITY

In the **Flow Groups, Clubs and Events** you can find fellow exercisers who train for the same event or in the same health club as you do. Or you can create your own group for the people you want to train with. You can share your exercises and training tips, comment other members' training results and be part of the Polar Community. In Flow Clubs you can view class schedules and sign up for classes. Join in and get motivation from your social training communities!

To see a video, click on the following link:

[Polar Flow Events](#)

PROGRAMS

The Polar Running Program is tailored for your goal, based on Polar heart rate zones, taking your personal attributes and training background into account. The program is intelligent, it adapts along the way based on your development. The Polar Running Programs are available for 5k, 10k, half marathon and marathon events, and consist of two to five running exercises per week depending on the program. It's super simple!

For support and more information about using the Flow web service, go to, support.polar.com/en/support/flow.

SPORT PROFILES IN POLAR FLOW

There are 12 default sport profiles on your watch. In the Polar Flow app or web service, you can add new sport profiles to your sports list and edit their settings. Your watch can contain a maximum of 20 sport profiles. If you have over 20 sport profiles in the Polar Flow app and web service, the first 20 in the list are transferred to your watch when syncing.

You can change the order of your sport profiles by dragging and dropping them. Choose the sport you want to move and drag it into the place you want to put it in the list.

To see a video, click on one of the following links:

[Polar Flow app | Sport profile editing](#)

[Polar Flow web service | Sport Profiles](#)

ADD A SPORT PROFILE

In the Polar Flow mobile app:

1. Go to **Sport profiles**.
2. Tap the plus sign in the upper right corner.
3. Choose a sport from the list. Tap Done on Android app. The sport is added to your sport profiles list.

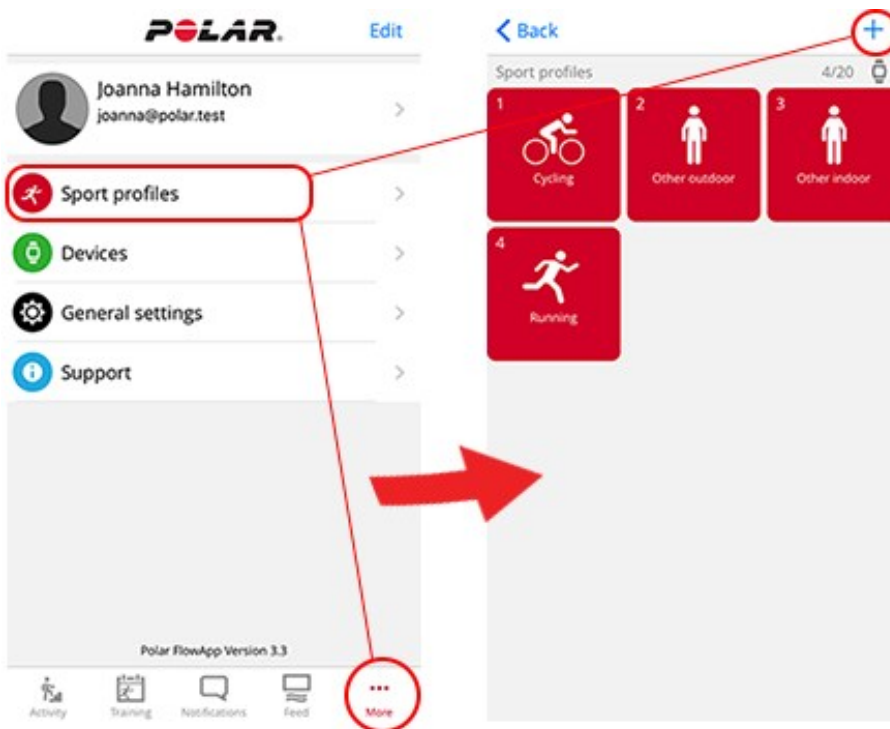

In the Polar Flow web service:

1. Click your name/profile photo in the upper right corner.
2. Choose **Sport Profiles**.
3. Click **Add sport profile**, and choose the sport from the list.
4. The sport is added to your sport list.



You can't create new sports yourself. The sports list is controlled by Polar, because each sport has certain default settings and values, which affect, for example, the calorie calculation and the training load and recovery feature.

EDIT A SPORT PROFILE

In the Polar Flow mobile app:

1. Go to **Sport profiles**.
2. Choose a sport and tap **Change settings**.
3. When you're ready, tap Done. Remember to sync the settings to your watch.

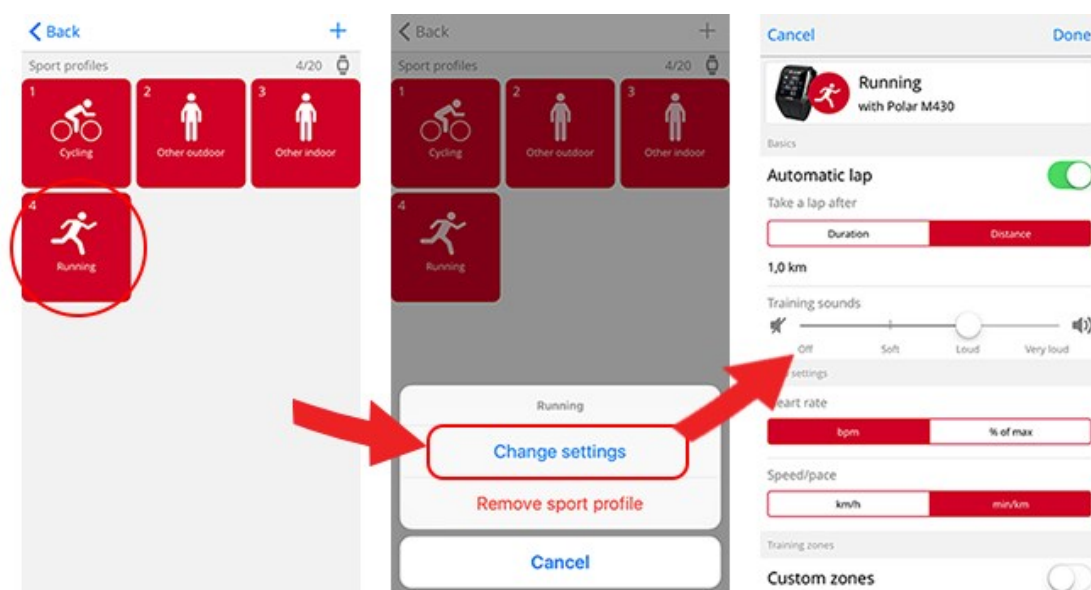

In the Flow web service:

1. Click your name/profile photo in the upper right corner.
2. Choose **Sport Profiles**.
3. Click **Edit** under the sport you want to edit.

In each sport profile, you can edit the following information:

Basics

- Automatic lap (Can be set to duration or distance-based or turned off Note: not available for Polar Unite)

Heart Rate

- Heart rate view (Beats per minute or % of maximum)
- Heart rate visible to other devices (This means that compatible devices using Bluetooth Smart wireless technology, e.g. gym equipment, can detect your heart rate. You can also use your watch during Polar Club classes to broadcast your heart rate to the Polar Club system.)
- Heart rate zone settings (With the heart rate zones you can easily select and monitor training intensities. If you choose Default, you cannot change heart rate limits. If you choose Free, all limits can be changed. Default heart rate zone limits are calculated from your maximum heart rate.)

Speed/Pace settings

- Speed/Pace view (Choose speed km/h / mph or pace min/km / min/mi)
- Speed/pace zone settings (With the speed/pace zones you can easily select and monitor your speed or pace, depending on your selection. Default zones are an example of speed/pace zones for a person with a relatively high fitness level. If you choose Default, you can't change the limits. If you choose Free, all limits can be changed.)

Training views

Choose what information you see on your training views during your sessions. You can have a total of eight different training views for each sport profile. Each training view can have a maximum of four different data fields.

Click the pencil icon on an existing view to edit it, or click **Add new view**.

Gestures and feedback

- Vibration feedback (You can choose to have vibration on or off)

GPS and altitude

- Choose the GPS recording rate (Can be set off or to **High accuracy**, meaning that the GPS recording is on)

When you're done with the sport profile settings, click **Save**. Remember to sync the settings to your watch.



Please note that in a number of indoor sports, group sports and team sports profiles the **HR visible to other devices** setting is enabled by default. This means that compatible devices using Bluetooth Smart wireless technology, e.g. gym equipment, can detect your heart rate. You can check which sport profiles have Bluetooth broadcasting enabled by default from the [Polar Sport profiles list](#). You can enable or disable Bluetooth broadcasting from sport profile settings.

PLANNING YOUR TRAINING

You can plan your training and create personal training targets for yourself in the Polar Flow web service or in the Polar Flow app.

CREATE A TRAINING PLAN WITH THE SEASON PLANNER

The [Season Planner](#) in the Flow web service is a great tool for creating a tailored annual training plan. No matter what your training goal is, Polar Flow helps you create a comprehensive plan to reach it. You can find the Season Planner tool from the **Programs** tab in the Polar Flow web service.

Annual Training Plan

01-10-2019 - 29-09-2019

221 Days left

176 Total sessions

202:40:05 Total duration

A B 1723.70 km Total distance

Season timeline

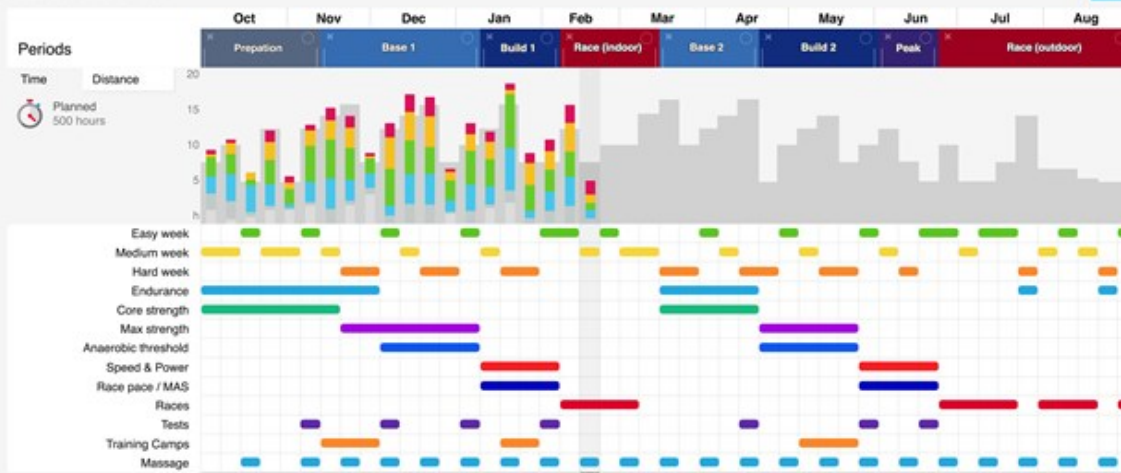

Mon 11-02-2019 - Sun 17-02-2019

This week Current period Race (indoor) Planned themes Medium week Races Massage

☆ Favorites Create favorite target

Race	Speed 1	Speed 2	Technique 1	Technique 2	3x4x200m intervals	6x600m intervals
6x1000m intervals	Pyramid intervals	Morning run	Long run	Uphills, short	Uphills, long	Explosive strength
Plyometric strength	Maximum strength	Core strength 1	Core strength 2	Endurance strength 1	Flexibility	Stretching



[Polar Flow for Coach](#) is a free remote coaching platform that allows your coach plan every detail of your training from full season plans to individual workouts.

CREATE A TRAINING TARGET IN THE POLAR FLOW APP AND WEB SERVICE

Note that the training targets need to be synced to your watch with FlowSync or via Flow app before you can use them. Your watch will guide you towards completing your target during training.

To create a training target in the Polar Flow web service:

1. Go to **Diary**, and click **Add > Training target**.
2. In the **Add training target**, choose **Sport**, enter **Target name** (maximum 45 digits), **Date** and **Time** and any **Notes** (optional) you want to add.

Then choose the type of your training target from the following:

DURATION TARGET

Choose a duration for your target in hours and minutes.

1. Choose **Duration**.
2. Enter the duration.
3. Click the **Add to favorites** ☆ to add the target to your list of favorites, if you want.
4. Click **Save** to add the target to your **Diary**.

DISTANCE TARGET

Choose a distance for your target in kilometers or miles.

1. Choose **Distance**.
2. Enter the distance.
3. Click the **Add to favorites** ☆ to add the target to your list of favorites, if you want.
4. Click **Save** to add the target to your **Diary**.

CALORIE TARGET

Choose a target based on how many calories you want to burn during your training session.

1. Choose **Calorie**.
2. Enter the amount of calories.
3. Click the **Add to favorites** ☆ to add the target to your list of favorites, if you want.
4. Click **Save** to add the target to your **Diary**.

INTERVAL TARGET

Choose a target based on intervals. Work some high intensity work phases and low intensity recovery periods into your training session to boost your routine.

1. Choose **Interval**.
2. Click **Repeat phases** to unlock the default interval target if, you want.
You can edit each phase by clicking the pen icon on the right: Choose **Name** and **Duration/Distance** for each phase, **Manual** or **Automatic** next phase start, and **Select intensity**. Then click **Done**. You can go back to edit the phases you've added by clicking the pen icon.
3. Click the **Add to favorites** ☆ to add the target to your list of favorites, if you want.
4. Click **Save** to add the target to your **Diary**.

PHASED TARGET

You can split your training session into phases and set a different duration and intensity for each of them. This one is for e.g. creating an interval training session, and adding proper warm-up and cool-down phases to it.

1. Choose **Phased**.
2. Choose whether you want to **Create new** or **Use template**.
 - Creating new: Add phases to your target. Click **Duration** to add a phase based on duration or click **Distance** to add a phase based on distance. Choose **Name** and **Duration/Distance** for each phase, **Manual** or **Automatic** next phase start, and **Select intensity**. Then click **Done**. You can go back to edit the phases you've added by clicking the pen icon.
 - Using the template: You can edit the template phases by clicking the pen icon on the right. You can add more phases to the template as instructed above for creating a new phased target.
3. Click the **Add to favorites** ☆ to add the target to your list of favorites.
4. Click **Save** to add the target to your **Diary**.

FAVORITES

If you have created a target and added it to your favorites, you can use it as a scheduled target.

1. In your **Diary**, Click **+Add** on the day when you want to use a favorite as a scheduled target.
2. Click **Favorite target** to open a list of your favorites.
3. Click the Favorite you want to use.
4. The Favorite is added to your diary as a scheduled target for the day. The default scheduled time for the training target is at 18.00/6pm. If you want to change the details of the training target, click the target in your **Diary**, and modify it to your liking. Then click **Save** to update the changes.

If you want to use an existing Favorite as a template for a training target, do the following:

1. Go to **Diary**, and click **Add > Training target**.
2. In the **Add training target** view, click **Favorite targets**. Your training target favorites are shown.
3. Click the Favorite as a template for your target.
4. Choose **Sport**, enter **Target name** (maximum 45 digits), **Date** and **Time** and any **Notes** (optional) you want to add.
5. Modify the Favorite according to your liking. Editing the target in this view won't change the original Favorite target.
6. Click **Add to Diary** to add the target to your **Diary**.

SYNC THE TARGETS TO YOUR WATCH

Remember to sync the training targets to your watch from the Flow web service via FlowSync or Flow App. If you don't sync them, they are only visible in your Flow web service Diary or Favorites list.

For information on starting a training target session, see [Start a training session](#).

FAVORITES

In **Favorites**, you can store and manage your favorite training targets in the Flow web service and the Flow mobile app. You can use your favorites as scheduled targets on your watch. For more information, see [Plan your training in the Flow web service](#).

You can see the maximum number of your watch. The number of favorites in the Flow web service is not limited. If you have over 20 favorites in the Flow web service, the first 20 in the list are transferred to your watch when syncing. You can change the order of your favorites by dragging and dropping them. Choose the favorite you want to move and drag it into the place you want to put it in the list.

ADD A TRAINING TARGET TO FAVORITES:

1. [Create a training target](#).
2. Click the favorites icon  on the lower right corner of the page.
3. The target is added to your favorites.

or

1. Open an existing target you've created from your **Diary**.
2. Click the favorites icon  on the lower right corner of the page.
3. The target is added to your favorites.

EDIT A FAVORITE

1. Click the favorites icon  on the upper right corner next to your name. All your favorite training targets are shown.
2. Click the favorite you want to edit, then click **Edit**.
3. You can change the sport, the target name, and you can add notes. You can alter the training details of the target under **Quick** or **Phased**. (For more information, see the chapter on [planning your training](#).) After you've done all the needed changes, click **Update changes**.

REMOVE A FAVORITE

1. Click the favorites icon  on the upper right corner next to your name. All your favorite training targets are shown.
2. Click the delete icon in upper right corner of the training target to remove it from the favorites list.

SYNCING

You can transfer data from your watch to the Polar Flow app wirelessly via Bluetooth connection. Or, you can sync your watch with the Polar Flow web service by using a USB port and the FlowSync software. To be able to sync data between your watch and the Flow app you need to have a Polar account. If you want to sync data from your watch directly to the

web service, in addition to a Polar account, you need the FlowSync software. If you've set up your watch, you have created a Polar account. If you set up your watch using a computer, you have the FlowSync software on your computer.

Remember to sync and keep your data up-to-date between your watch, the web service and the mobile app wherever you are.

SYNC WITH FLOW MOBILE APP

Before syncing make sure:

- You have a Polar account and Flow app.
- Your mobile device has Bluetooth turned on, and airplane mode/flight mode is not turned on.
- You have paired your watch with your mobile. For more information, see [Pairing](#).

Sync your data:

1. Sign in to the Flow app, and press and hold the BACK button on your watch until **Connecting to phone** is displayed on your watch.
2. **Connecting to Polar Flow app** is displayed on your watch.
3. **Syncing completed** is displayed on your watch when you are done.



Your watch syncs with the Flow app automatically after you finish a training session if your phone is within the Bluetooth range. When your watch syncs with the Flow app, your activity and training data are also synced automatically via an internet connection to the Flow web service.

For support and more information about using the Polar Flow app, go to support.polar.com/en/support/Flow_app.

SYNC WITH FLOW WEB SERVICE VIA FLOWSYNC

To sync data with the Flow web service you need the FlowSync software. Go to flow.polar.com/start, and download and install it before trying to sync.

1. Plug your watch to your computer. Make sure FlowSync software is running.
2. The FlowSync window opens on your computer, and the syncing starts.
3. Completed is displayed when you are done.

Every time you plug in your watch to your computer, the Polar FlowSync software will transfer your data to the Polar Flow web service and sync any settings you may have changed. If the syncing does not automatically start, start FlowSync from the desktop icon (Windows) or from the applications folder (Mac OS X). Every time a firmware update is available, FlowSync will notify you, and request you to install it.



If you change settings in the Flow web service while your watch is plugged into your computer, press the synchronize button on FlowSync to transfer to the settings to your watch.

For support and more information about using the Flow web service, go to support.polar.com/en/support/flow.

For support and more information about using FlowSync software, go to support.polar.com/en/support/FlowSync.

IMPORTANT INFORMATION

BATTERY

At the end of the working life of the product Polar encourages you to minimize possible effects of waste on the environment and human health by following local waste disposal regulations and, where possible, utilizing separate collection of electronic devices. Do not dispose of this product as unsorted municipal waste.

BATTERY LIFETIME AND OPERATIONAL TIME

The Polar Unite has an internal, rechargeable battery. Rechargeable batteries have a limited number of charge cycles. You can charge and discharge the battery over 500 times before a notable decrease in its capacity. The number of charge cycles also varies according to use and operating conditions.

The battery operating time is:

- Up to 50 hours in training mode with optical heart rate and connected GPS, or
- Up to 4 days in watch mode with continuous heart rate measurement.

The operating time depends on many factors, such as the temperature of the environment in which you use your watch, the features and sensors you use, and battery aging. Phone notifications and frequent syncing with Flow app will also decrease the battery life. The operating time is significantly reduced in temperatures well below freezing. Wearing your watch under your overcoat helps to keep it warmer and to increase the operating time.



The Continuous heart rate tracking is **on by default** in Polar Unite. Keeping the Continuous heart rate tracking on in your watch will drain the battery quicker. Using the **night-time only mode** will extend the battery life. You can turn the Continuous heart rate tracking on, off or to night-time only mode on your watch in **Settings > General settings > Continuous HR tracking**.



Backlight always on during training: With always on the watch display will be illuminated throughout your training session. The backlight setting will default back to automatic after you finish your training session. Please note that selecting always on will drain your battery much faster.

CHARGING THE BATTERY



Before charging, please make sure there's no moisture, dust or dirt on the charging contacts of your watch and USB charging adapter. Gently wipe off any dirt or moisture. Do not charge the watch when it's wet.



Do not charge the battery in temperatures under 0 °C/ +32 °F or over +40 °C/ +104 °F or when the USB port is wet. Attach the USB charging adapter to the watch **before** connecting the adapter to the power supply. Don't leave the USB charging adapter connected to the power supply **without** the watch.

Use the USB charging adapter included in the product set to charge it via the USB port on your computer. You can also charge the battery via a wall outlet. When charging via a wall outlet, use a USB power adapter (not included in the product set).

You can charge the battery via a wall outlet. When charging via a wall outlet, use a USB power adapter (not included in the product set). If you use a USB power adapter, make sure that the adapter is marked with "output 5Vdc" and that it provides a minimum of 500mA. Only use an adequately safety approved USB power adapter (marked with "LPS", "Limited Power Supply", "UL listed" or "CE").



i Do not charge Polar products with a 9 volt charger. Using a 9 volt charger can damage your Polar product.

To charge with your computer, just plug your watch to your computer, and at the same time, you can have it synced it with FlowSync.

1. To charge your watch, plug it into a powered USB port or a USB charger with the USB charging adapter that came in the box. Align the pins of the USB charging adapter with the pins on the watch and snap the adapter into place. Also make sure that you plug the USB charging adapter in the right way, i.e. **the four pins on the Polar Unite USB charging adapter must face the four pins in your computer's USB port or in the USB charger.**

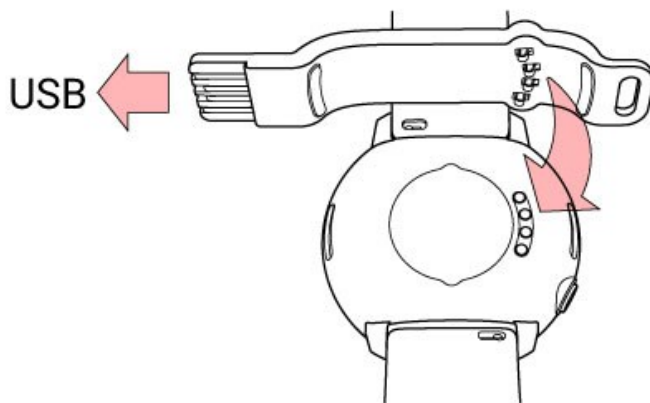

2. **Charging** appears on the display.
3. When the battery icon is full, the watch is fully charged.

i Don't leave the battery fully discharged for a long period of time or keep it fully charged all the time, because it may affect the battery life time.

BATTERY STATUS AND NOTIFICATIONS

BATTERY STATUS SYMBOL

The battery status symbol is shown when you turn your wrist to look at the watch or return to time view from the menu. There is also a battery status icon in the [Quick settings menu](#), which shows how much charge is left on the battery as a percentage.

BATTERY NOTIFICATIONS

- When the battery charge is low, **Battery low. Charge** is shown in time mode. It is recommended to charge the watch.
- **Charge before training** is shown if the charge is too low for recording a training session.

Low battery notifications during training:

- **Battery low** is shown when the battery charge is getting low. The notification is repeated if the charge gets too low for measuring heart rate and GPS data and the heart rate measurement and GPS are switched off.

- When the battery is critically low, **Recording ended** is shown. Your watch stops the training recording and saves the training data.

When the display is blank, the battery is empty and your watch has gone to sleep mode. Charge your watch. If the battery is totally drained, it may take a while for the charging animation to appear on the display.

The operating time depends on many factors, such as the temperature of the environment in which you use your watch, the features and sensors you use, and battery aging. Frequent syncing with Flow app will also decrease the battery life. The operating time is significantly reduced in temperatures well below freezing. Wearing the watch under your overcoat helps to keep it warmer and to increase the operating time.

CARING FOR YOUR WATCH

Like any electronic device, the Polar Unite should be kept clean and treated with care. The instructions below will help you fulfill the guarantee obligations, keep the device in peak condition and avoid any issues in charging or syncing.

KEEP YOUR WATCH CLEAN

Wash the watch under running water with a mild soap and water solution after each training session. Wipe it dry with a soft towel.

Keep the charging contacts of your watch and USB charging adapter clean to ensure smooth charging and syncing.

Before charging, please make sure there's no moisture, dust or dirt on the charging contacts of your watch and USB charging adapter. Gently wipe off any dirt or moisture. **Do not charge the watch when it's wet or sweaty.**

Keep the charging contacts of your watch clean to effectively protect your watch from oxidation and other possible damage caused by dirt and salt water (e.g. sweat or sea water). The best way to keep the charging contacts clean is to rinse the watch after each training session with lukewarm tap water. The watch is water resistant and you can rinse it under running water without damaging the electronic components.

TAKE GOOD CARE OF THE OPTICAL HEART RATE SENSOR

Keep the optical sensor area on the back cover scratch-free. Scratches and dirt will reduce the performance of the wrist-based heart rate measurement.

STORING

Keep your training device in a cool and dry place. Do not keep it in a damp environment, in non-breathable material (a plastic bag or a sports bag) nor with conductive material (a wet towel). Do not expose the training device to direct sunlight for extended periods, such as by leaving it in a car or mounted on the bike mount. It is recommended to store the training device partially or fully charged. The battery slowly loses its charge when it is stored. If you are going to store the training device for several months, it is recommended to recharge it after a few months. This will prolong the battery lifetime.

Do not leave the device in extreme cold (below $-10\text{ }^{\circ}\text{C}/14\text{ }^{\circ}\text{F}$) and heat (above $50\text{ }^{\circ}\text{C}/120\text{ }^{\circ}\text{F}$) or under direct sunlight.

SERVICE

During the two-year guarantee/warranty period we recommend that you have service done by an authorized Polar Service Center only. The warranty does not cover damage or consequential damage caused by service not authorized by Polar Electro. For further information, see Limited International Polar Guarantee.

For contact information and all Polar Service Center addresses, visit support.polar.com and country-specific websites.

PRECAUTIONS

Polar products (training devices, activity trackers and accessories) are designed to indicate the level of physiological strain and recovery during and after exercise session. The Polar training devices and activity trackers measure heart rate and/or tell your activity. The Polar training devices with an integrated GPS show speed, distance and location. See www.polar.com/en/products/accessories for a complete list of compatible accessories. The Polar training devices with a barometric pressure sensor measure altitude and other variables. No other use is intended or implied. The Polar training device should not be used for obtaining environmental measurements that require professional or industrial precision.

INTERFERENCE DURING TRAINING

Electromagnetic Interference and Training Equipment

Disturbance may occur near electrical devices. Also WLAN base stations may cause interference when training with the training device. To avoid erratic reading or misbehavior, move away from possible sources of disturbance.

Training equipment with electronic or electrical components such as LED displays, motors and electrical brakes may cause interfering stray signals. To solve these problems, try the following:

1. Remove the heart rate sensor strap from your chest and use the training equipment as you would normally.
2. Move the training device around until you find an area in which it displays no stray reading or does not flash the heart symbol. Interference is often worst directly in front of the display panel of the equipment, while the left or right side of the display is relatively free of disturbance.
3. Put the heart rate sensor strap back on your chest and keep the training device in this interference-free area as much as possible.

If the training device still does not work with the training equipment, it may be electrically too noisy for wireless heart rate measurement.

MINIMIZING RISKS WHEN TRAINING

Training may include some risk. Before beginning a regular training program, it is recommended that you answer the following questions concerning your health status. If you answer yes to any of these questions, we recommend that you consult a doctor before starting any training program.

- Have you been physically inactive for the past 5 years?
- Do you have high blood pressure or high blood cholesterol?
- Are you taking any blood pressure or heart medication?
- Do you have a history of breathing problems?
- Do you have symptoms of any disease?
- Are you recovering from a serious illness or medical treatment?
- Do you use a pacemaker or other implanted electronic device?
- Do you smoke?
- Are you pregnant?

Note that in addition to training intensity, medications for heart conditions, blood pressure, psychological conditions, asthma, breathing, etc., as well as some energy drinks, alcohol, and nicotine may also affect heart rate.

It is important to be sensitive to your body's responses during training. **If you feel unexpected pain or excessive fatigue when training, it is recommended that you stop the training or continue at a lighter intensity.**

Note! If you are using a pacemaker or other implanted electronic device, you can use Polar products. In theory interference to pacemaker caused by Polar products should not be possible. In practice no reports exist to suggest anyone ever having experienced interference. We cannot however issue an official guarantee on our products' suitability with all pacemakers or other implanted devices due to the variety of devices available. If you have any doubts, or if you experience

any unusual sensations while using Polar products, please consult your physician or contact the implanted electronic device manufacturer to determine safety in your case.

If you are allergic to any substance that comes into contact with your skin or if you suspect an allergic reaction due to using the product, check the listed materials in [Technical Specifications](#). If you experience any skin reaction, stop using the product and consult your physician. Also inform Polar Customer Care about your skin reaction. To avoid any skin reaction to the heart rate sensor, wear it over a shirt, but moisten the shirt well under the electrodes to ensure flawless operation.



The combined impact of moisture and intense abrasion may cause color to come off the heart rate sensor's surface, possibly staining light-colored clothes. It may also cause a darker color to come off clothing, possibly staining lighter-colored training devices. To keep a light-colored training device glowing for years to come, please make sure the clothing you wear while training does not bleed color. If you use perfume or insect repellent on your skin, you must ensure that it does not come into contact with the training device or the heart rate sensor. If you train in cold conditions (-20 °C to -10 °C / -4 °F to 14 °F) we recommend that you wear the training device under the sleeve of your jacket, directly on your skin.

WARNING - KEEP BATTERIES OUT OF REACH OF CHILDREN

Polar heart rate sensors (for example H10 and H9) contain a button cell battery. If the button cell battery is swallowed, it can cause severe internal burns in as little as 2 hours and can lead to death. **Keep new and used batteries away from children.** If the battery compartment does not close securely, stop using the product and keep it away from children. **If you think batteries might have been swallowed or placed inside any part of the body, seek immediate medical attention.**

Your safety is important to us. The shape of the Polar stride sensor Bluetooth® Smart is designed to minimize the possibility of getting caught in something. In any case, be careful when running with the stride sensor in brushwood, for example.

HOW TO USE YOUR POLAR PRODUCT SECURELY

Data security updates are performed two years onwards from a product's announced end-of-life date. Please update your Polar product regularly, and as soon as the Polar Flow mobile application or Polar FlowSync computer software informs you about the availability of a new firmware version.

Training session data and other data saved on your Polar device include sensitive information about you such as your name, physical information, overall health and location. Location data can be used to track you when you are out training and to find out what your usual routes are. For these reasons use extra caution when storing your device when not using it.

If you use phone notifications on your wrist device, be aware that messages from certain applications will be projected on the wrist device display. Your latest messages can also be viewed from the device menu. To ensure the confidentiality of your private messages, refrain from using the phone notifications feature.

Before handing the device over to a third party for testing or before selling it, it is necessary to perform a factory reset on the device, and to remove the device from your Polar Flow account. A factory reset can be performed with the FlowSync software on your computer. A factory reset will clear the device memory, and the device cannot be linked to your data anymore. To remove the device from your Polar Flow account, sign into the Polar Flow web service, choose products and click the "Remove" button next to the product you wish to remove.

The same training sessions are also stored on your mobile device with the Polar Flow application. For extra security, various security enhancing options can be enabled on your mobile device such as strong authentication and device encryption. Consult the user manual of your mobile device for instructions on enabling these options.

When using the Polar Flow web service, we recommend using a password that is no less than 12 characters in length. If using the Polar Flow web service on a public computer, please remember to clear the cache and browsing history in order

to prevent others from accessing your account. In addition, do not allow a computer's browser to store or remember your password for the Polar Flow web service if it is not your private computer.

Any security issues can be reported to security@polar.com or to Polar Customer Care.

TECHNICAL SPECIFICATION

POLAR UNITE

Battery type:	174 mAh Li-pol rechargeable battery
Operating time:	In continuous use: Up to 50 hours in training mode with optical heart rate and connected GPS Up to 4 days in watch mode with continuous heart rate tracking
Operating temperature:	-10 °C to +50 °C / 14 °F to 122 °F
Watch materials:	Device: ABS+10GF, GLASS, PMMA, STAINLESS STEEL Wristband: SILICONE, Pin: PA+50GF
Accessory wristband materials:	Woven wristbands Wristband: recycled PET yarn Elasticated section: 50% polyester, 50% natural rubber Leather wristbands Wristband: leather Lining: alcantara Elasticated section: 50% polyester, 50% natural rubber
USB charging adapter materials:	ABS+PC, GOLD PLATED STAINLESS STEEL
Water resistance:	30 m (ISO 22810, suitable for swimming)
Memory capacity:	Up to 90 hours of training with GPS and heart rate depending on your language settings
Display	Color touch display (IPS TFT) with Ambient Light Sensor (ALS), Resolution: 240 x 204

Maximum power	5 mW
Frequency	2.402 - 2.480 GHz

Uses wireless Bluetooth® technology.

POLAR FLOWSYNC SOFTWARE

To use FlowSync software you need a computer with Microsoft Windows or Mac operating system with an internet connection and a free USB port.

Check the latest compatibility information from support.polar.com.

POLAR FLOW MOBILE APPLICATION COMPATIBILITY

Check the latest compatibility information from support.polar.com.

WATER RESISTANCE OF POLAR PRODUCTS

Most Polar products can be worn when swimming. They are not, however, diving instruments. When measuring heart rate in water with a GymLink compatible Polar device and heart rate sensor, you may experience interference for the following reasons:

- Pool water with high chlorine content, and seawater are very conductive. The electrodes of the heart rate sensor may short-circuit, preventing ECG signals from being detected by the heart rate sensor.
- Jumping into water or strenuous muscle movement during competitive swimming may shift the heart rate sensor to a location on the body where ECG signals cannot be picked up.
- The ECG signal strength is individual and may vary depending on the individual's tissue composition. Problems occur more frequently when measuring heart rate in water.

In the watch industry, water resistance is generally indicated as meters, which means the static water pressure of that depth. Polar uses this same indication system. Water resistance of Polar products is tested according to International Standard **ISO 22810** or **IEC60529**. Every Polar device that has water resistance indication is tested before the delivery to stand water pressure.

Polar products are divided into four different categories according to their water resistance. Check the back of your Polar product for the water resistance category, and compare it to the chart below. Please note that these definitions do not necessarily apply to products of other manufacturers.

When performing any underwater activity, the dynamic pressure generated by moving in water is greater than the static pressure. This means that moving the product under water subjects it to a greater pressure than if the product were stationary.

Marking on the back of the product	Wash splashes, sweat, rain-drops etc.	Bathing and swimming	Skin diving with snorkel (no air tanks)	SCUBA diving (with air tanks)	Water resistant characteristics
Water resistant IPX7	OK	-	-	-	Do not wash with a pressure washer. Protected against splashes, raindrops etc. Reference standard: IEC60529.
Water resistant IPX8	OK	OK	-	-	Minimum for bathing and swimming.

					Reference standard: IEC60529.
Water resistant Water resistant 20/30/50 meters Suitable for swimming	OK	OK	-	-	Minimum for bathing and swimming. Reference standard: ISO22810.
Water resistant 100 meters	OK	OK	OK	-	For frequent use in water but not SCUBA diving. Reference standard: ISO22810.

REGULATORY INFORMATION



This product is compliant with Directives 2014/53/EU, 2011/65/EU and 2015/863/EU. The relevant Declaration of Conformity and other regulatory information for each product are available at www.polar.com/en/regulatory_information.



This crossed out wheeled bin marking shows that Polar products are electronic devices and are in the scope of Directive 2012/19/EU of the European Parliament and of the Council on waste electrical and electronic equipment (WEEE) and batteries and accumulators used in products are in the scope of Directive 2006/66/EC of the European Parliament and of the Council of 6 September 2006 on batteries and accumulators and waste batteries and accumulators. These products and batteries/accumulators inside Polar products should thus be disposed of separately in EU countries. Polar encourages you to minimize possible effects of waste on the environment and human health also outside the European Union by following local waste disposal regulations and, where possible, utilize separate collection of electronic devices for products, and battery and accumulator collection for batteries and accumulators.

To see the Polar Unite-specific regulatory labels, go to **Settings > General settings > About your watch**.

LIMITED INTERNATIONAL POLAR GUARANTEE

- Polar Electro Oy issues a limited international guarantee for Polar products. For products which have been sold in the USA or Canada, guarantee is issued by Polar Electro, Inc.
- Polar Electro Oy/Polar Electro Inc. guarantees the original consumer/purchaser of the Polar product that the product will be free from defects in material or workmanship for two (2) years from the date of purchase, with the exception of wristbands made of silicone or plastic, which are subject to a guarantee period of one (1) year from the date of purchase.
- The guarantee does not cover normal wear and tear of the battery, or other normal wear and tear, damage due to misuse, abuse, accidents or non-compliance with the precautions; improper maintenance, commercial use, cracked, broken or scratched cases/displays, textile armband or textile or leather wristband, elastic strap (e.g. heart rate sensor chest strap) and Polar apparel.
- The guarantee does also not cover any damage/s, losses, costs or expenses, direct, indirect or incidental, consequential or special, arising out of, or related to the product.
- Guarantee does not cover products which have been purchased second hand.
- During the guarantee period, the product will be either repaired or replaced at any of the authorized Polar Central Services regardless of the country of purchase.

- Guarantee issued by Polar Electro Oy/Inc. does not affect the consumer's statutory rights under applicable national or state laws in force, or the consumer's rights against the dealer arising from their sales/purchase contract.
- You should keep the receipt as a proof of purchase!
- Guarantee with respect to any product will be limited to countries where the product has been initially marketed by Polar Electro Oy/Inc.

Manufactured by Polar Electro Oy, Professorintie 5, 90440 KEMPELE, Finland www.polar.com.

Polar Electro Oy is a ISO 9001:2015 certified company.

© 2020 Polar Electro Oy, 90440 KEMPELE, Finland. All rights reserved. No part of this manual may be used or reproduced in any form or by any means without prior written permission of Polar Electro Oy.

The names and logos in this user manual or in the package of this product are trademarks of Polar Electro Oy. The names and logos marked with a ® symbol in this user manual or in the package of this product are registered trademarks of Polar Electro Oy. Windows is a registered trademark of Microsoft Corporation and Mac OS is a registered trademark of Apple Inc. The Bluetooth® word mark and logos are registered trademarks owned by Bluetooth SIG, Inc. and any use of such marks by Polar Electro Oy is under license.

DISCLAIMER

- The material in this manual is for informational purposes only. The products it describes are subject to change without prior notice, due to the manufacturer's continuous development program.
- Polar Electro Inc./Polar Electro Oy makes no representations or warranties with respect to this manual or with respect to the products described herein.
- Polar Electro Inc./Polar Electro Oy shall not be liable for any damages, losses, costs or expenses, direct, indirect or incidental, consequential or special, arising out of, or related to the use of this material or the products described herein.

1.0 EN 05/2020